

GERMAN
POOL



德國寶

多功能智能電飯煲
Multifunctional Rice Cooker

MRC-105

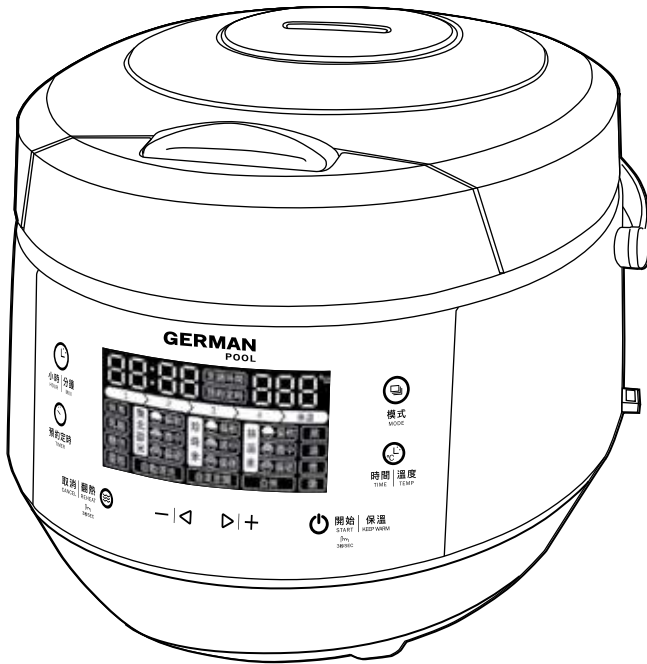

在使用之前請詳細閱讀「使用說明書」及「保用條款」，並妥為保存。
Please read these instructions and warranty information carefully
before use and keep them handy for future reference.

使用說明書 USER MANUAL

請即進行保用登記!

有關保用條款細則，請看本說明書最後一頁。

Please register your warranty information now!

**For Warranty Terms & Conditions,
please refer to the last page of this user manual.**

目錄

全新多功能智能電飯煲特色 04

注意事項 05

產品結構 06

操作說明 07

A. 按鍵說明 07

B. 控制面版 07

C. 預約操作的使用方式 08

D. 功能表操作詳解 08

清潔與保養 13

電路原理圖 14

技術規格 14

保用條款 27

For English instructions, please refer to P.15.
英文版說明書請參閱 P.15。

全新多功能智能電飯煲特色



1:1 黃金煮飯比例

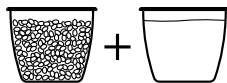

九種煮飯模式

針對絲苗米、珍珠米及東北御米

白米種類繁多，大致可分為長米粒和短米粒。長米粒較細長，形狀扁平，黏性弱，當中包括口感香爽之絲苗米等。短米粒粗短闊厚，黏性較長米粒強，口感香軟，包括珍珠米及東北御米等。由於白米形狀、特徵及黏性各有不同，所需的烹調時間及溫度亦不盡相同。德國寶多功能智能電飯煲，特設九種煮飯模式，針對絲苗米、珍珠米及東北御米的特性，通過微電腦悉心調節溫度及時間，配合1:1黃金比例，只需1杯米加一杯水，按鍵即煮出軟糯、軟硬適中或嚼勁極致的香噴噴米飯，叫人食指大動！



絲苗米

幼長甘香，色澤潔白，口感煙韌彈牙。泰國茉莉香米在泰國東北地區才可種植，帶天然茉莉花香，飯粒幼長香糯。



珍珠米

珍珠米顆粒飽滿、米質油潤、味道香甜，含豐富蛋白質及不飽和脂肪等。珍珠米煮成的米飯，粘而不膩，為米中佳品。



東北御米

中國東北地區晝夜溫差大，特適合大米生長。東北御米屬於粳米，粒形短圓，含水量較高，直鏈澱粉含量適中，煮出來的米飯潔白透亮，口感細膩。

9種內設模式：



注意事項

重要說明

為安全起見，使用產品前請先細閱本說明書，並保存說明書，以便作參考之用。
本產品只供家居使用。請必須依照本說明書內的指示操作。

1. 此款飯煲不適合殘疾人和兒童操作，當飯煲工作時，切勿讓兒童接觸飯煲。
2. 切勿直接將飯煲放入水中清洗，以免造成短路和觸電。
3. 切勿將任何金屬插入飯煲縫隙中，以免觸電。
4. 切勿用濕手插入或拔出插頭，以免觸電。拔出插頭時切勿直接拉扯電源線。不要用力拉扯或屈曲電源線。
5. 切勿將電源線用於其他加熱設備，以避免火災。使用過後，應及時拔出插頭。
6. 定時清潔插頭金屬部位，以免接觸不良。
7. 插頭需使用容量大於10A的獨立插座。確保插頭完全插入插座，連接良好。
8. 請勿將臉或手靠近排氣孔，以免燙傷。切勿用布蓋住排氣孔，以免鍋蓋因為過熱而扭曲變形。
9. 飯煲工作時，請勿用手直接接觸鍋蓋或任何金屬部位，以免燙傷。如需搬動飯煲，請妥為蓋好飯煲，以免燙傷。
10. 切勿將飯煲放在不穩定或不耐高溫的物體上，以免引發火災。
11. 請勿將飯煲放在易燃或者潮濕的環境，以免引發任何災害。
12. 使用之前請先清潔發熱盤、溫度感測器和內鍋外側，避免接觸不良。
13. 不可劇烈敲擊內鍋，內鍋變形可能造成飯煲出現故障或引發使用危險。
14. 切勿使用損害性工具清潔內鍋，以免損壞不粘塗層。
15. 切勿使用其他燃料加熱飯煲，切勿使用其他內鍋代替原裝內鍋，以免引發危險。
16. 內鍋未放置好；無放置內鍋；或者內鍋未為裝有食材或水時，請勿通電工作。
17. 使用後，飯煲發熱盤會很燙，請勿觸摸，以免燙傷。
18. 如未經培訓，使用者請勿自行拆卸產品或更換零件。如需維修，請聯繫售後維修點。
19. 若電源線損壞，請勿擅自更換其他電源線，請聯繫維修點更換合適的電源線。



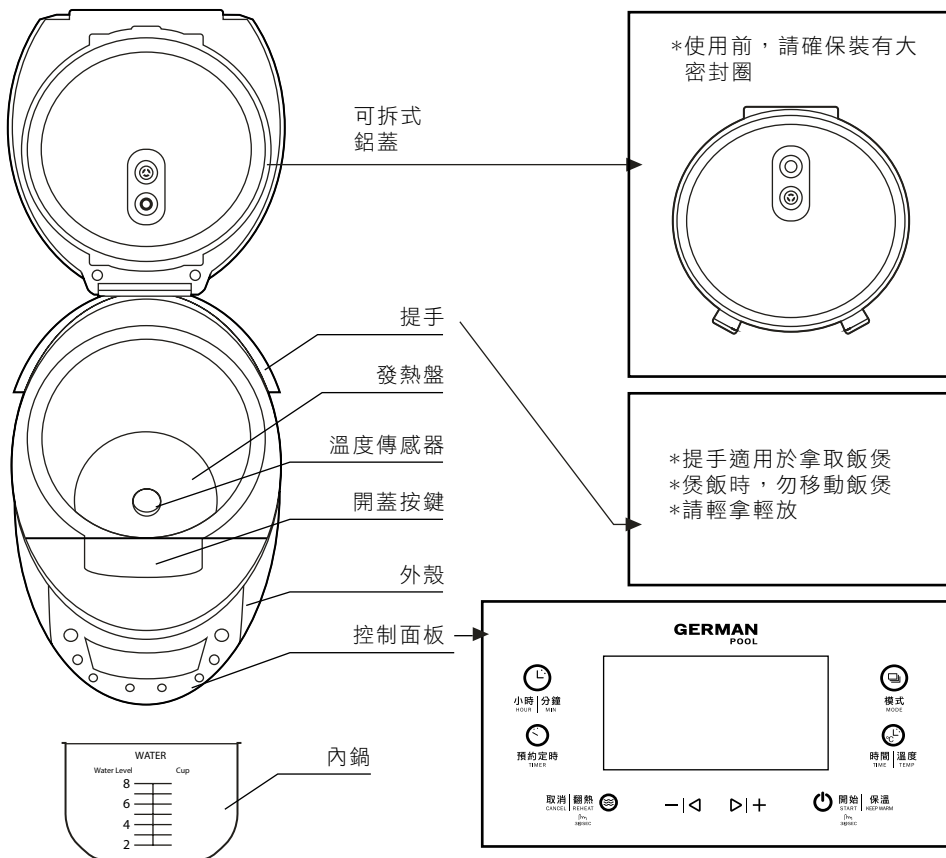

產品結構

(產品外觀與圖片可能有所不同，請以實物為準。)

機身



配件

飯勺	湯勺	量杯	蒸籠	電源線
				

操作說明

A. 按鍵說明



開始/保溫鍵

長按此鍵3秒開始工作，工作狀態下按此鍵可開啟和關閉保溫功能。最長保溫時間為24小時。



模式鍵

按此按鍵可以選擇所需要的功能。



小時 | 分鐘
HOUR | MIN

小時/分鐘鍵

按下此鍵可以更改時間。



時間 | 溫度
TIME | TEMP

時間/溫度鍵

當某一功能有調節溫度和時間的功能時，可以在先按下此鍵的情況下再按鍵調節烹飪溫度和烹飪時間。



預約定時
TIMER

預約定時鍵

當某一功能有「預約」功能時，按下此鍵可以預約時間。



「+」「-」功能鍵

在先按下時間/溫度鍵的情況下，可以按下此鍵調節時間和溫度，也可按此鍵選擇烹飪功能表。









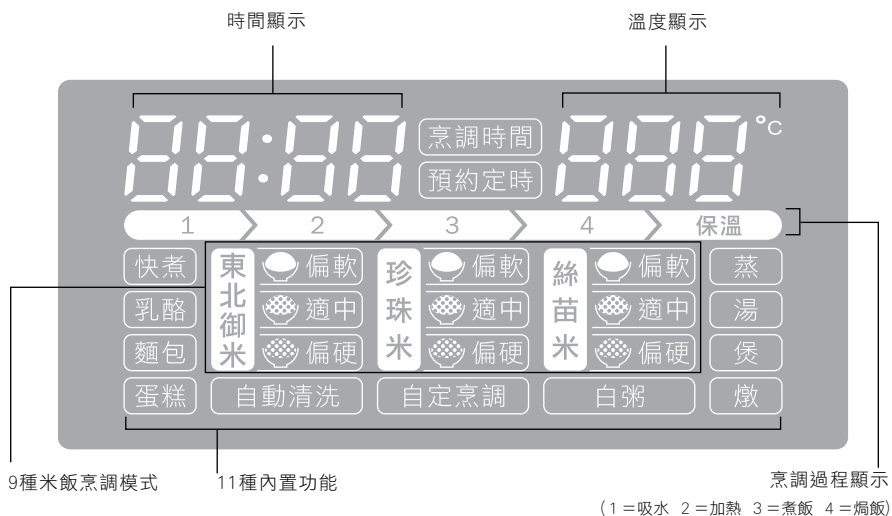



取消/翻熱鍵

按此鍵可取消當前程序；待機時長按此鍵3秒開啟翻熱功能。





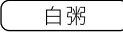





B. 控制面板

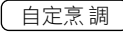

C. 預約操作的使用方法





















- 選擇烹飪功能後，按  「預約定時」鍵，數碼屏顯示預約時間，可按   鍵調節預約時間，設置完成後長按  「開始/保溫」鍵3秒進入預約模式，並開始倒數計時。
- 預約設置完成後，如需調整烹飪時間，先不按  「開始/保溫」鍵，而是按  「時間/溫度」鍵，當數碼屏顯示烹飪時間時，可按   鍵調整烹飪時間，設置完成後，長按  「開始/保溫」鍵3秒進入預約模式，預約時間結束後按設定的烹飪程序開始工作。
- 預約時間調節範圍為5分鐘到24小時。預約時間為程式開始工作時間，以  功能為例：如當前時間為中午12:00，晚飯時間為下午6:00，因白粥的烹煮時間為2小時，故將預約時間調為下午4:00（4小時後開始工作）即可，按下  「開始/保溫」鍵，下午6:00即可享用白粥。









































D. 功能表操作詳解













自定烹調	<ol style="list-style-type: none">1)按  「模式」鍵或   鍵選擇  功能（該功能默認工作時間為30分鐘，預設工作溫度為100℃）。2)按  「時間/溫度」鍵，然後按   鍵調節烹飪時間，調節範圍：2分鐘-15小時（調節時可以按  「小時/分鐘」鍵進行分鐘與小時的切換），一小時內每一間隔為1分鐘，超過一小時每一間隔為5分鐘。3)再按  「時間/溫度」鍵，通過按   鍵調節烹飪溫度，調節範圍：35℃-180℃，每按一次，溫度增減為5℃。4)長按  「開始/保溫」鍵3秒進入工作狀態。5)烹飪結束後，如溫度在75℃或以上，飯煲自動進入保溫狀態（除非手動取消保溫）。 <p><i>小提示：如果烹飪溫度低於75℃，烹飪結束後飯煲不會自動保溫。 如果烹飪溫度超過140℃，烹飪時間不能超過2個小時。 該功能可以進行24小時預約工作。</i></p>
-------------	---

























注意：

本機設有斷電記憶功能，於斷電後2小時內接通電源，飯煲將會自動繼續之前的烹飪程序。如要中途結束烹調程序，請務必先按取消鍵，再關閉電源開關，否則於2小時內再次接通電源時，飯煲將自動按上次設定的烹調程序繼續進行運作。

<p>快煮</p>	<ol style="list-style-type: none"> 1)按  「模式」 鍵或   鍵選擇  功能（該功能默認工作時間為15分鐘）。 2)烹飪時間不可調校。 3)長按  「開始/保溫」 鍵3秒進入工作狀態。 4)烹飪結束後，飯煲自動進入保溫狀態(除非用戶手動取消保溫)。 <p><i>小提示：該功能不可以進行24小時預約工作。</i></p>
<p>煲</p>	<ol style="list-style-type: none"> 1)按  「模式」 鍵選擇  功能（該功能默認工作時間為1小時）。 2)按  「時間/溫度」 鍵，然後按   鍵調節烹飪時間，調節範圍：10分鐘-12小時（調節時可以按  「小時/分鐘」 鍵進行分鐘與小時的切換），每一間隔為5分鐘。 3)長按  「開始/保溫」 鍵3秒進入工作狀態。 4)烹飪結束後，飯煲自動進入保溫狀態(除非用戶手動取消保溫)。 <p><i>小提示：該功能可以進行24小時預約工作。</i></p>
<p>白粥</p>	<ol style="list-style-type: none"> 1) 按  「模式」 鍵或   鍵選擇  功能（該功能默認工作時間為2小時）。 2)按  「時間/溫度」 鍵，然後按   鍵調節烹飪時間，調節範圍：5分鐘-4小時（調節時可以按  「小時/分鐘」 鍵進行分鐘與小時的切換），每一間隔為5分鐘。 3)長按  「開始/保溫」 鍵3秒進入工作狀態。 4)烹飪結束後，飯煲自動進入保溫狀態(除非用戶手動取消保溫)。 <p><i>小提示：該功能可以進行24小時預約工作。</i></p>

<p>湯</p>	<p>1) 按  「模式」 鍵或   鍵選擇  功能（該功能默認工作時間為1小時）。</p> <p>2) 按  「時間/溫度」 鍵，然後按   鍵調節烹飪時間，調節範圍：10分鐘-8小時（調節時可以按  「小時/分鐘」 鍵進行分鐘與小時的切換），每一間隔為5分鐘。</p> <p>3) 長按  「開始/保溫」 鍵3秒進入工作狀態。</p> <p>4) 烹飪結束後，飯煲自動進入保溫狀態(除非用戶手動取消保溫)。</p> <p><u>小提示：該功能可以進行24小時預約工作。</u></p>																											
<p>9項米飯功能</p>	<p>1) 按  「模式」 鍵或   鍵選擇心儀的米飯功能:</p> <table border="0" data-bbox="370 627 972 715"> <tr> <td>1 東北御米偏軟功能</td> <td>4 珍珠米偏軟功能</td> <td>7 絲苗米偏軟功能</td> </tr> <tr> <td>2 東北御米適中功能</td> <td>5 珍珠米適中功能</td> <td>8 絲苗米適中功能</td> </tr> <tr> <td>3 東北御米偏硬功能</td> <td>6 珍珠米偏硬功能</td> <td>9 絲苗米偏硬功能</td> </tr> </table> <div data-bbox="437 722 897 850" style="text-align: center;"> <table border="1" style="border-collapse: collapse; width: 100%;"> <tr> <td style="background-color: black; color: white; text-align: center; padding: 5px;">東北御米</td> <td style="text-align: center; padding: 5px;"> 偏軟</td> <td style="background-color: black; color: white; text-align: center; padding: 5px;">珍珠米</td> <td style="text-align: center; padding: 5px;"> 偏軟</td> <td style="background-color: black; color: white; text-align: center; padding: 5px;">絲苗米</td> <td style="text-align: center; padding: 5px;"> 偏軟</td> </tr> <tr> <td></td> <td style="text-align: center; padding: 5px;"> 適中</td> <td></td> <td style="text-align: center; padding: 5px;"> 適中</td> <td></td> <td style="text-align: center; padding: 5px;"> 適中</td> </tr> <tr> <td></td> <td style="text-align: center; padding: 5px;"> 偏硬</td> <td></td> <td style="text-align: center; padding: 5px;"> 偏硬</td> <td></td> <td style="text-align: center; padding: 5px;"> 偏硬</td> </tr> </table> </div> <p>2) 烹飪時間取決於米量和水量的多少，不可調節。米和水的建議比例為1:1。</p> <p>3) 長按  「開始/保溫」 鍵3秒進入工作狀態。</p> <p>4) 開始煮食時時間區域顯示00：12，在燜飯階段才以倒計時的形式顯示剩餘工作時間，此階段為12分鐘。</p> <p>5) 烹飪結束後，飯煲自動進入保溫狀態(除非用戶手動取消保溫)。</p> <p><u>小提示：該功能可以進行24小時預約工作。</u></p>	1 東北御米偏軟功能	4 珍珠米偏軟功能	7 絲苗米偏軟功能	2 東北御米適中功能	5 珍珠米適中功能	8 絲苗米適中功能	3 東北御米偏硬功能	6 珍珠米偏硬功能	9 絲苗米偏硬功能	東北御米	 偏軟	珍珠米	 偏軟	絲苗米	 偏軟		 適中		 適中		 適中		 偏硬		 偏硬		 偏硬
1 東北御米偏軟功能	4 珍珠米偏軟功能	7 絲苗米偏軟功能																										
2 東北御米適中功能	5 珍珠米適中功能	8 絲苗米適中功能																										
3 東北御米偏硬功能	6 珍珠米偏硬功能	9 絲苗米偏硬功能																										
東北御米	 偏軟	珍珠米	 偏軟	絲苗米	 偏軟																							
	 適中		 適中		 適中																							
	 偏硬		 偏硬		 偏硬																							

<p>燉</p>	<ol style="list-style-type: none"> 1)按  「模式」鍵或 — ◀ ▶ + 鍵選擇 燉 功能（該功能默認工作時間為5小時）。 2)按  「時間/溫度」鍵，然後按 — ◀ ▶ + 鍵調節烹飪時間，調節範圍：10分鐘-8小時（調節時可以按  「小時/分鐘」鍵進行分鐘與小時的切換），每一間隔為10分鐘。 3)長按  「開始/保溫」鍵3秒進入工作狀態。 4)烹飪結束後，飯煲自動進入保溫狀態(除非用戶手動取消保溫)。 <i><u>小提示：該功能可以進行24小時預約工作。</u></i>
<p>麵包</p>	<ol style="list-style-type: none"> 1)按  「模式」鍵或 — ◀ ▶ + 鍵選擇 麵包 功能（該功能默認工作時間為2小時30分鐘）。 2)按  「時間/溫度」鍵，然後按 — ◀ ▶ + 鍵調節烹飪時間，調節範圍：10分鐘-6小時（調節時可以按  「小時/分鐘」鍵進行分鐘與小時的切換），每一間隔為5分鐘。 3)長按  「開始/保溫」鍵3秒進入工作狀態。 4)烹飪結束後，飯煲自動進入保溫狀態，繼續保溫兩小時(除非用戶手動取消保溫)。 <i><u>小提示：該功能可以進行24小時預約工作。</u></i>
<p>蛋糕</p>	<ol style="list-style-type: none"> 1)按  「模式」鍵或 — ◀ ▶ + 鍵選擇 蛋糕 功能（該功能默認工作時間為50分鐘）。 2)按  「時間/溫度」鍵，然後按 — ◀ ▶ + 鍵調節烹飪時間，調節範圍：10分鐘-8小時（調節時可以按  「小時/分鐘」鍵進行分鐘與小時的切換），每一間隔為5分鐘。 3)長按  「開始/保溫」鍵3秒進入工作狀態。 4)烹飪結束後，飯煲進入待機狀態，不保溫。 <i><u>小提示：該功能不可以進行24小時預約工作。</u></i>

<p>乳酪</p>	<ol style="list-style-type: none"> 1)按  「模式」 鍵或   鍵選擇 乳酪 功能（該功能默認工作時間為8小時）。 2)按  「時間/溫度」 鍵，然後按   鍵調節烹飪時間，調節範圍：10分鐘-12小時（調節時可以按  「小時/分鐘」 鍵進行分鐘與小時的切換），每一間隔為5分鐘。 3)長按  「開始/保溫」 鍵3秒進入工作狀態。 4)烹飪結束後，飯煲進入待機，不保溫。 <p><i>小提示：該功能可以進行24小時預約工作。</i></p>
<p>蒸</p>	<ol style="list-style-type: none"> 1)按  「模式」 鍵或   鍵選擇 蒸 功能（該功能默認工作時間為20分鐘）。 2)按  「時間/溫度」 鍵，然後按   鍵調節烹飪時間，調節範圍：5分鐘-2小時（調節時可以按  「小時/分鐘」 鍵進行分鐘與小時的切換），每一間隔為5分鐘。 3)長按  「開始/保溫」 鍵3秒進入工作狀態。 4)當水煮開了，提示音響起，然後開始倒計時。 5)烹飪結束後，飯煲自動進入保溫狀態(除非用戶手動取消保溫)。 <p><i>小提示：該功能不可以進行24小時預約工作。</i></p>
<p>自動清洗</p>	<ol style="list-style-type: none"> 1)按  「模式」 鍵或   鍵選擇 自動清洗 功能（該功能默認工作時間為30分鐘）。 2)按  「時間/溫度」 鍵，然後按   鍵調節烹飪時間，調節範圍：5分鐘-2小時（調節時可以按  「小時/分鐘」 鍵進行分鐘與小時的切換），每一間隔為5分鐘。 3)長按  「開始/保溫」 鍵3秒進入工作狀態。 4)當水煮開了，提示音響起，然後開始倒數計時。 5)烹飪結束後，飯煲自動進入保溫狀態(除非用戶手動取消保溫)。 <p><i>小提示：該功能可以進行24小時預約工作。</i></p>

清潔與保養

1. 清洗前，請先拔下電源插頭。
2. 將內鍋取出，使用家用清潔劑清洗，然後用柔軟的布料擦乾。
3. 不使用時，請將飯煲放置於乾燥的環境中。
4. 使用過後，請將可拆式鋁蓋卸掉，用水清洗乾淨，並用柔軟的布料擦乾。
5. 使用過後，請清洗蒸氣出氣口，避免產生異味，避免蒸氣口出現故障。

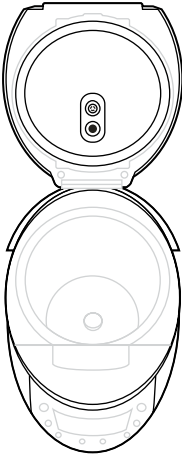

鋁蓋，塑膠面蓋及塑膠外殼

請用柔軟的濕布擦拭清潔。

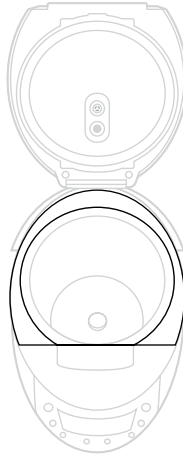

集蒸氣水區域

此區域會聚集烹飪過程中水蒸氣聚集生成的水。每次烹飪後，請使用柔軟布料將水擦拭乾淨。

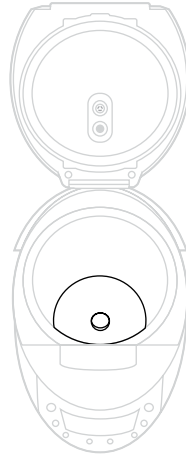

溫度傳感器及發熱盤

溫度傳感器和發熱盤上如有雜質，會影響烹飪效果。請在每次使用之前，將溫度傳感器和發熱盤清潔乾淨。

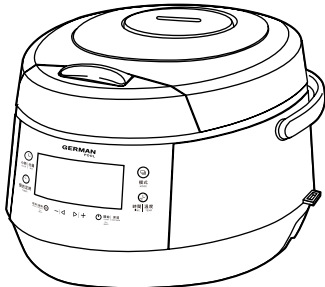

蒸氣座

每次使用過後，請將蒸氣座清洗乾淨。

電路原理圖

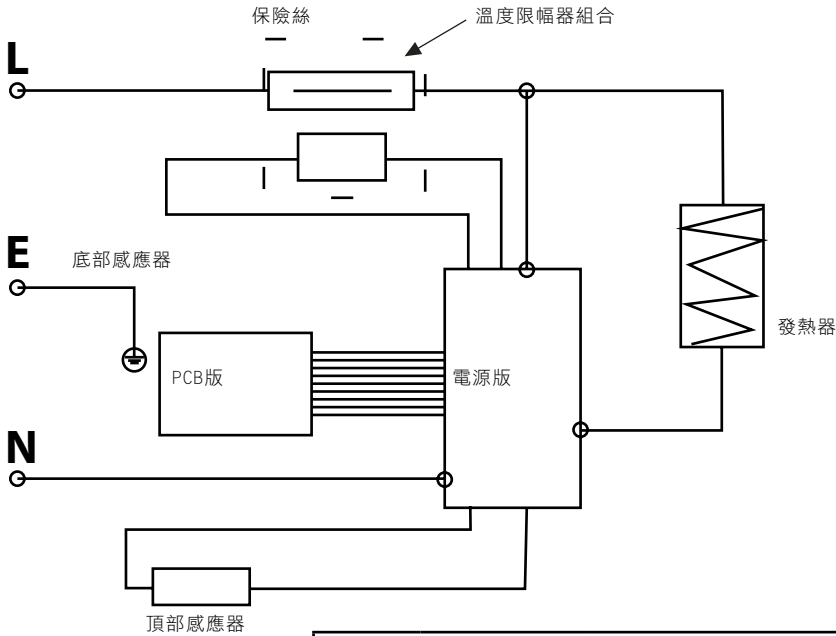

錯誤代碼		
編號	顯示幕顯示	原因
1	E1	底部感測器開路
2	E2	頂部感測器開路
3	E3	底部感測器短路
4	E4	頂部感測器短路

技術規格

型號	MRC-105
電壓/頻率	220-240 V ~ 50/60 Hz
額定功率	950W
容量	5L

產品規格及設計如有變更，恕不另行通知。
 中英文版本如有出入，一概以中文版為準。
 本產品使用說明書以www.germanpool.com網上版為最新版本。

Table of Contents

Feature of Multifunctional Rice Cooker	16
Notice Before Use	17
Product Structure	18
Operation Instructions	19
A. Control Buttons	19
B. LED Display Panel	19
C. Using the Timer	20
D. Detailed Operation	20
Cleaning and Maintenance	21
Circuit Diagram	22
Specifications	23
Warranty Terms & Conditions	24

Feature of Multifunctional Rice Cooker



1:1 Golden Ratio

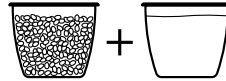

9 Innovative Rice Cooking Modes For Chinese, Japanese, Thai Rice Grains For Different Palates

There are many different strains of rice. They can be roughly divided into long and short grain rice. The long grain rice is slenderer in shape, and is generally less sticky than the short grain variant. Thai fragrant rice is a type of long grain rice. Short grain rice is typified by Japanese and Chinese rice, both of which are stout and has a softer texture. Long grain rice and short grain rice require different cooking conditions for bringing out the best flavour and texture. The Multifunctional Rice Cooker has **9 built-in cooking modes that target the specific property of each kind of rice. Now, with the 1:1 golden ration delicate, al dente, and hard tasting rice is available at the touch of a button with a cup of rice & water!**



Thai rice

This slender and fragrant strain of rice has an al dente texture and an ivory colour. Thai rice is grown in the northeastern region of Thailand, and has a natural hint of jasmine.



Japanese rice

Japanese rice has a pearly round shape and has a rich and sweet texture. This strain of rice is rich in protein and unsaturated fat. A bowl derived from Japanese rice is slightly sticky without being overwhelmingly so.



Chinese rice

The northeastern part of China is especially suited for the growth of rice for the region experiences huge diurnal temperature variation. Chinese rice has a round shape and is abundant in water content. The cooked rice is deliciously translucent with a delicate texture.

9 Modes:

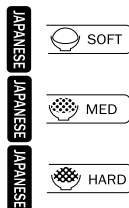

Notice Before Use

Important

For safety, you should read the instructions carefully before using the appliance. Retain the instructions for future reference.

The appliance is designed for domestic use only, and may only be installed and operated in accordance with this instruction manual.



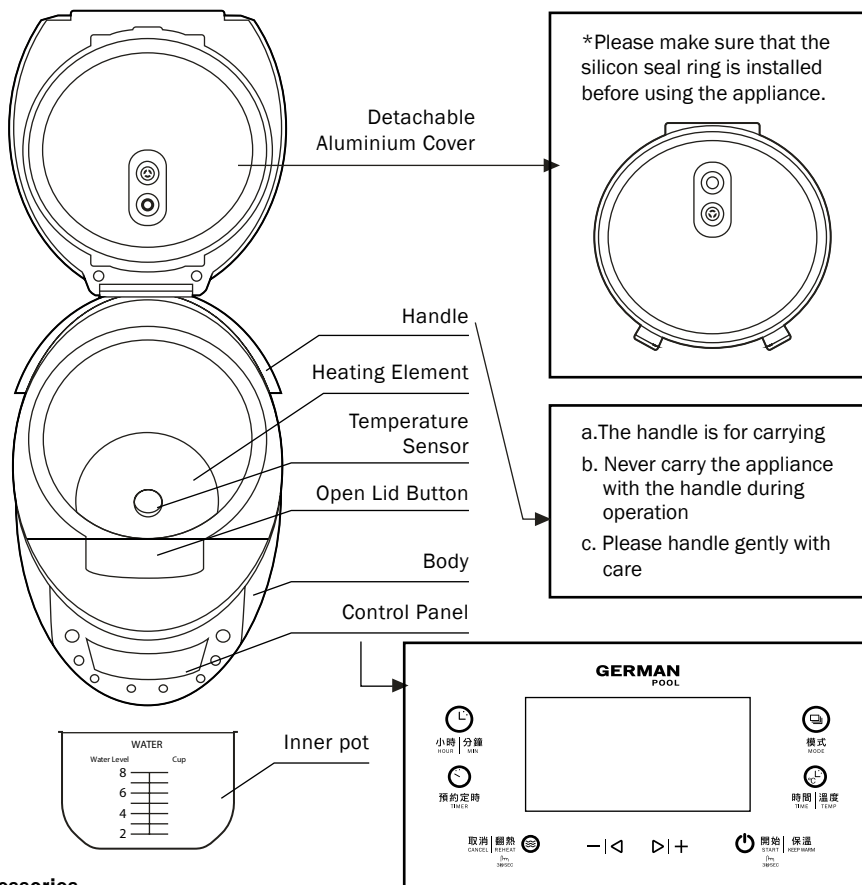

1. This appliance is not suitable for children and handicapped people. Please always keep children from the appliance during operation.
2. Never wash this appliance in water directly to avoid short circuit and electric shock.
3. Never plug any metal into the gaps or holes on this appliance to avoid possible electric shock.
4. Never plug or unplug the power supply plug with a wet hand to avoid electric shock. Never unplug the power cord by pulling the cable. The power cable should not be pulled or twisted violently.
5. The power cord should not be in contact with other heating appliance to avoid fire hazards. Always unplug the power cord after use.
6. Clean the metal parts on the plug from time to time to avoid weak contact.
7. Please always connect this appliance to an independent socket with the capacity above 10A, and make sure that the plug is completely plugged in and well contacted.
8. Always keep hand and face away from the steam outlet to avoid scalding by the steam, and never cover the steam outlet with cloth, otherwise the cover may be distorted due to over heating.
9. During the operation, never touch the cover or any metal parts of the appliance to avoid scalding. When carrying the appliance, please keep the cover closed to avoid scalding.
10. This appliance should not be used on any unstable or other objects which can not resist high temperature, otherwise fire hazard may happen.
11. Please keep the appliances from fire, damp surrounding to avoid possible hazard.
12. Before use, please always clean the heating element, the temperature sensor and the exterior bottom of the inner pot to avoid weak contact.
13. The inner pot is not allowed for any violent impact. Any distortion of the inner pot may cause malfunction and other hazards.
14. Never clean the inner pot with any abrasive or hazardous tools to avoid damage to the non-stick coating.
15. Never heat the inner pot with other heating source, and never use other pot to replace the inner pot of this appliance to avoid any possible hazards.
16. Never start the appliance without the inner pot in position or with the absence of any water or other food in an empty pot.
17. The heating disk will be very hot after use, never touch it with hand to avoid scalding.
18. No untrained person is allowed to disassemble the appliance. If repair is needed, please contact the service center.
19. If the power cord is damaged, never replace it with any other power cables, please contact the service center for the correct power cord.

Product Structure

The actual product may be different from the images below, the appearance of the actual product shall prevail.



Accessories

Rice Spoon	Soup Spoon	Measuring Cup	Steaming Basket	Power Cord
				

Operation Instructions

A. Control Buttons



START/KEEP WARM BUTTON

Press this button for 3 seconds to start the programme. The KEEP WARM function can be cancelled or restarted by pressing this button during the cooking process. Maximum keep warm period is 24 hours.



模式
MODE

MODE BUTTON

Press to choose a programme.



HOUR/MIN BUTTON

Press to change the time between hour and minute.



TIME/TEMP BUTTON

If the cooking time or cooking temperature of the selected programme can be adjusted, the user can press this button and then press "+" or "-" to adjust the cooking time and temperature.



TIMER BUTTON

Press to preset the time before cooking if the selected programme has the "timer" function.



"+"OR"-"BUTTON

press to adjust time or temperature after pressing the timer button. You can also press this button to select a cooking programme.





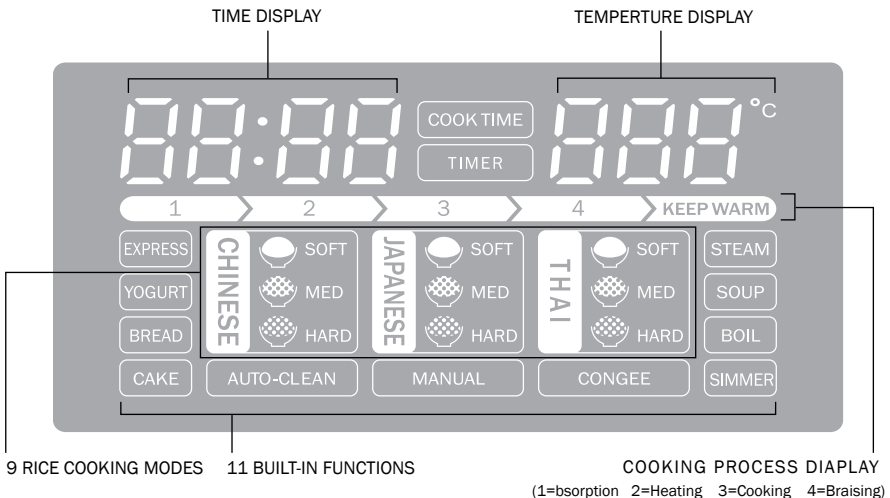

CANCEL/REHEAT BUTTON

Press to cancel the current program or press for 3 seconds to reheat.





B. LED Display Panel



C. Using the Timer



























- a. Select the cooking programme. Press the “Timer” button, then the display will show the preset time. The user can adjust the preset time by pressing the $\leftarrow|<$ $>|+$ button. Keep pressing  “Start/Keep warm” button for 3 seconds after all settings are done, and the preset time will count down.
- b. If the user wants to adjust the cooking time after setting the timer, the user should not press the  “Start/Keep warm” button. The user should press  “Timer/Temperature” button and press $\leftarrow|<$ $>|+$ to adjust the cooking time. Then keep pressing  “Start/Keep warm” button for 3 seconds, the preset time will count down. When preset time count down to 00:00, relevant cooking program will start.
- c. Preset time adjusting range is 5 minutes to 24 hours. The preset time refers to “how long it will take” to make cooking programme start. Take the cooking programme for example: The cooking time of is 2 hours. It's 12 o'clock now, the user wants to have dinner at 6:00p.m. The user can set the preset time to 4:00p.m. (After 4 hours). Then press the  “Start/Keep warm” button. The congee will be ready at 6:00p.m.



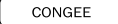























D. Detailed Operation

































Manual	<ol style="list-style-type: none">1) Press  “Mode” button or $\leftarrow <$ $> +$ to choose <input type="text" value="MANUAL"/> function. (Default cooking time is 30 minutes, default cooking temperature is 100°C).2) Press  “Time/Temp” button, then press $\leftarrow <$ $> +$ button to adjust cooking time between range of 2 minutes-15 hours (can switch between hour adjustment and minute adjustment by press  “Hour/minute” button), adjusting step is 1 minute within one hour and adjusting step is 5 minutes above one hour.3) Press  “Time/Temp” button again, then press $\leftarrow <$ $> +$ button to adjust cooking temperature within range of 35°C-180°C, at 5°C per step.4) Keep pressing  “Start/Keep warm” button for three seconds to start the cooking programme.5) When finishing cooking, the appliance automatically keeps warm if cooking temperature is 75°C and above, unless user cancels the keep warm function manually during cooking process. <p>Tips: The appliance will not “keep warm” after cooking finishes if cooking temperature is below 75°C, if cooking temperature is more than 140°C, cooking time cannot exceed 2 hours; 24-hour preset cooking is available for this mode.</p>
---------------	---

































Notice:

The rice cooker is equipped with memory function. It will automatically continue the previous programme once connect to power within 2 hours. To stop a cooking programme halfway, please press the cancel button, and then switch off power, or the cooker will automatically start with the latest selected programme when connect to power within 2 hours.

<p>Express</p>	<p>1) Press  “Mode” button or    button to choose  function. (Default cooking time is 15 minutes).</p> <p>2) Cooking time is not adjustable.</p> <p>3) Keep pressing  “Start/Keep warm” button for three seconds to start the cooking programme.</p> <p>4) When cooking finishes, the appliance automatically keeps warm, unless user cancels the keep warm function manually during cooking process.</p> <p>Tips: 24-hour preset cooking is available for this mode.</p>
<p>Boil</p>	<p>1) Press  “Mode” button or    button to choose  function. (Default cooking time is 1 hour).</p> <p>2) Press  “Time/Temp” button, then press    button to adjust cooking time between range of 10 minutes-12 hours (can switch between hour adjustment and minute adjustment by press  “Hour/Minute” button), adjusting step is 5 minutes.</p> <p>3) Keep pressing  “Start/Keep warm” button for three seconds to start the cooking programme.</p> <p>4) When cooking finishes, the appliance automatically keeps warm, unless user cancels the keep warm function manually during the cooking process.</p> <p>Tips: 24-hour preset cooking is available for this mode.</p>
<p>Congee</p>	<p>1) Press  “Mode” button or    button to choose  function. (Default cooking time is 2 hours).</p> <p>2) Press  “Time/Temp” button, then press    button to adjust cooking time between range of 5 minutes-4 hours (can switch between hour adjustment and minute adjustment by press  “Hour/Min” button), adjusting step is 5 minutes.</p> <p>3) Keep pressing  “Start/Keep warm” button for three seconds to start the cooking programme.</p> <p>4) When cooking finishes, the appliance automatically keeps warm, unless user cancels the keep warm function manually during the cooking process.</p> <p>Tips: 24-hour preset cooking is available for this mode.</p>

<p>Soup</p>	<p>1) Press  "Mode" button or    button to choose  function. (Default cooking time is 1 hour).</p> <p>2) Press  "Time/Temp" button, then press    button to adjust cooking time between range of 10 minutes-8 hours (can switch between hour adjustment and minute adjustment by press  "Hour/Min" button), adjusting step is 5 minutes.</p> <p>3) Keep pressing  "Start/Keep Warm" button for three seconds to start the cooking programme.</p> <p>4) When cooking finishes, the appliance automatically keeps warm, unless user cancels the keep warm function manually during the cooking process.</p> <p>Tips: 24-hour preset cooking is available for this mode.</p>
<p>Rice (nine modes)</p>	<p>1) Press  "Mode" button or    button to choose your desired rice texture, including:</p> <p>1 Chinese rice soft function 4 Japanese rice soft function 7 Thai rice soft function 2 Chinese rice med function 5 Japanese rice med function 8 Thai rice med function 3 Chinese rice hard function 6 Japanese rice hard function 9 Thai rice hard function</p> <div style="display: flex; justify-content: center; gap: 20px;"> <div style="border: 1px solid black; padding: 5px; display: flex; flex-direction: column; align-items: center;"> <div style="writing-mode: vertical-rl; transform: rotate(180deg); font-weight: bold; font-size: small;">CHINESE</div> <div style="display: flex; gap: 10px;"> <div style="text-align: center;"> SOFT</div> <div style="text-align: center;"> MED</div> <div style="text-align: center;"> HARD</div> </div> </div> <div style="border: 1px solid black; padding: 5px; display: flex; flex-direction: column; align-items: center;"> <div style="writing-mode: vertical-rl; transform: rotate(180deg); font-weight: bold; font-size: small;">JAPANESE</div> <div style="display: flex; gap: 10px;"> <div style="text-align: center;"> SOFT</div> <div style="text-align: center;"> MED</div> <div style="text-align: center;"> HARD</div> </div> </div> <div style="border: 1px solid black; padding: 5px; display: flex; flex-direction: column; align-items: center;"> <div style="writing-mode: vertical-rl; transform: rotate(180deg); font-weight: bold; font-size: small;">THAI</div> <div style="display: flex; gap: 10px;"> <div style="text-align: center;"> SOFT</div> <div style="text-align: center;"> MED</div> <div style="text-align: center;"> HARD</div> </div> </div> </div> <p>2) Cooking time and are unadjustable. Cooking time depends on the quantity of the rice and water. Suggested rice and water ratio (1:1).</p> <p>3) Keep pressing  "Start/Keep warm" button for three seconds to start the cooking programme.</p> <p>4) The display reads 00:12 after  "Start/Keep warm" button is pressed. Countdown starts when the rice braising process begins. (This process lasts for 12 minutes).</p> <p>5) When cooking finishes, the appliance automatically keeps warm, unless user cancels the keep warm function manually during the cooking process.</p> <p>Tips: 24-hour preset cooking is available for this mode.</p>

<p>Simmer</p>	<p>1) Press  "Mode" button or    button to choose  function. (Default cooking time is 5 hours).</p> <p>2) Press  "Time/Temp" button, then press    button to adjust cooking time within range of 10 minutes-8 hours (can switch between hour adjustment and minute adjustment by press  "Hour/Min" button), adjusting step is 10 minutes.</p> <p>3) Keep pressing  "Start/Keep warm" button for three seconds to start the cooking programme.</p> <p>4) When cooking finishes, the appliance automatically keeps warm, unless user cancels the keep warm function manually during the cooking process.</p> <p>Tips: 24-hour preset cooking is available for this mode.</p>
<p>Bread</p>	<p>1) Press  "Mode" button or    button to choose  function (Default cooking time is 2 hours and 30 minutes).</p> <p>2) Press  "Time/Temp" button, then press    button to adjust cooking time between range of 10 minutes - 6 hours (can switch between hour adjustment and minute adjustment by press  "Hour/Min" button), adjusting step is 5 minutes.</p> <p>3) Keep pressing  "Start/Keep warm" button for three seconds to start the cooking programme.</p> <p>4) When cooking finishes, the appliance automatically keeps warm, unless user cancels the keep warm function manually during the cooking process. Keep warm will continue for a maximum 2 hours.</p> <p>Tips: 24-hour preset cooking is available for this mode.</p>
<p>Cake</p>	<p>1) Press  "Mode" button or    button to choose  function (Default cooking time is 50 minutes).</p> <p>2) Press  "Time/Temp" button, then press    button to adjust cooking time between range of 10 minutes - 8 hours (can switch between hour adjustment and minute adjustment by press  "Hour/Min" button).</p> <p>3) Keep pressing  "Start/Keep warm" button for three seconds to start cooking programme.</p> <p>4) When cooking finishes, the appliance automatically goes into standby, no keep warm.</p> <p>Tips: 24-hour preset cooking is available for this mode.</p>

<p>Yogurt</p>	<ol style="list-style-type: none"> 1) Press  "Mode" button or    button to choose  function. (Default cooking time is 8 hours). 2) Press  "Time/Temp" button, then press    button to adjust cooking time between range of 10 minutes-12 hours (can switch between hour adjustment and minute adjustment by press  "Hour/Min" button). 3) Keep pressing  "Start/Keep warm" button for three seconds to start cooking programme. 4) When cooking finishes, the appliance automatically goes into standby, no keep warm. <p>Tips: 24-hour preset cooking is available for this mode.</p>
<p>Steam</p>	<ol style="list-style-type: none"> 1) Press  "Mode" button or    button to choose  function (Default cooking time is 20 minutes). 2) Press  "Time/Temp" button, then press    button to adjust cooking time between range of 5 minutes-2 hours (can switch between hour adjustment and minute adjustment by press  "Hour/Min" button), adjusting step is 5 minutes. 3) Keep pressing  "Start/Keep Warm" button for three seconds to start cooking programme. 4) When water in cooking pot is boiled, a sound can be heard, then countdown starts. 5) When cooking finishes, the appliance automatically keeps warm, unless user cancels the keep warm function manually during the cooking process. <p>Tips: 24-hour preset cooking is available for this mode.</p>
<p>Auto-clean</p>	<ol style="list-style-type: none"> 1) Press  "Mode" button or    button to choose  function. (Default cooking time is 30 minutes). 2) Press  "Time/Temp" button, then press    button to adjust time between range of 5 minutes-2 hours (can switch between hour adjustment and minute adjustment by press  "Hour/Min" button), adjusting step is 5 minutes. 3) Keep pressing  "Start/Keep Warm" button for three seconds to start the cooking programme. 4) When the programme finishes, the appliance automatically keeps warm, unless user cancels the keep warm function manually during the cooking process. <p>Tips: 24-hour preset cooking is available for this mode.</p>

Cleaning and Maintenance

1. Unplug power prior to cleaning.
2. Take the inner pot out of the appliance, clean it with home detergent and dry it with a soft cloth.
3. If not in use, please dry the body of the appliance and put it in a dry environment.
4. After use, please take down the detachable aluminium cover lid and clean it with water, and clean the inside of the top cover with a soft cloth.
5. The steam outlet should be cleaned after use, to prevent the development of odour or the malfunctioning of the steam outlet.

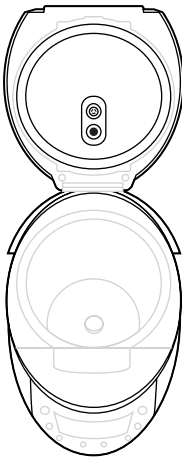

Aluminium cover, plastic lid and plastic cover

Please clean with a soft damp cloth.

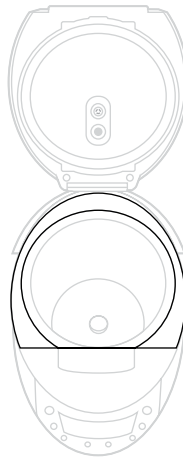

Areas affected by condensation

There may be small volume of water left in this area due to the condensation of hot steam, please clear the water each time after use.

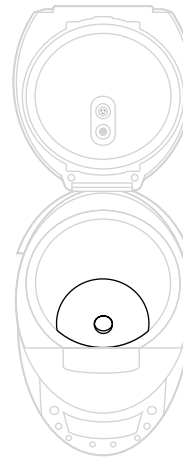

Temperature sensor and heating element.

Any residues left on the temperature sensor and the heating element may affect the cooking effect, please clean these parts each time before use.



Steam valve

Should be cleared each time after cooking.

Circuit Diagram

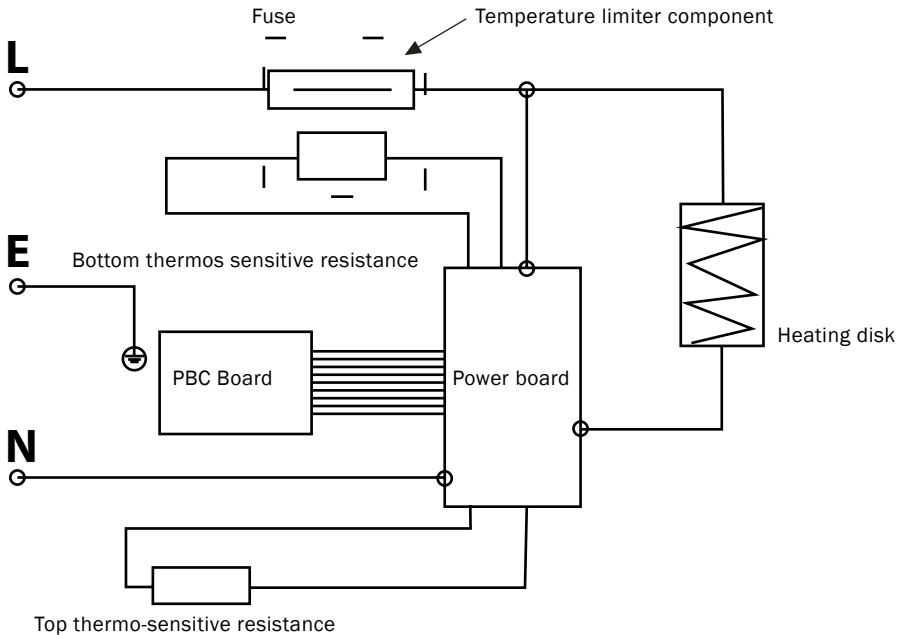

Problem Shooting		
No.	Indication on the displayer	Reason
1	E1	Bottom temperature sensor open circuited
2	E2	Upper temperature sensor open circuited
3	E3	Bottom temperature sensor short circuited
4	E4	Upper temperature sensor short circuited

Specifications

Model	MRC-105
Voltage/ Frequency	220-240 V ~ 50/60 Hz
Power	950W
Capacity	5L

Specifications are subject to change without notice.

If there is any inconsistency or ambiguity between the Chinese version and the English version, the Chinese version shall prevail.

Refer to www.germanpool.com for the most up-to-date version of the User Manual.

請填寫以下表格並與發票一併保存，以便維修時核對資料。用戶提供本公司之所有資料必須正確無誤，否則免費保用將會無效。
Please fill out the form below. This information and the purchase invoice will be required for any repairs. Warranty will be invalid if information provided is found to be inaccurate.

型號 Model No. : MRC-105

機身號碼 Serial No. : _____

發票號碼 Invoice No. : _____

購買商號 Purchased From : _____

購買日期 Purchase Date : _____

保用條款

此保用提供德國寶產品之機件在正常使用下一年保用(自購買日起計算)。

* 貴戶須在購機十天內，以下列其中一種方式向本公司登記資料，保用手續方正式生效：

- 1) 填妥本公司網頁內之保用登記表格
www.germanpool.com/warranty。
- 2) 填妥保用登記卡，並連同購機發票傳真至客戶服務部。

1. 未能出示購買發票正本者，將不獲免費維修服務。
2. 用戶應依照說明書的指示操作。本保用並不包括：
 - 因天然與人為意外造成的損壞(包括運輸及其他)；
 - 任何塑膠附件及輔助裝置；
 - 電源接合不當、不依說明書而錯誤或疏忽使用本機所引致之損壞。
3. 於下列情況下，用戶之保用資格將被取消：
 - 購買發票有任何非認可之刪改；
 - 產品被用作商業或工業用途；
 - 產品經非認可之技術人員改裝或加裝任何配件；
 - 機身編號被擅自塗改、破壞或刪除。
4. 總代理有權選擇維修或更換配件或其損壞部份。
5. 產品一經被轉讓，其保用即被視作無效。

客戶服務及維修中心

德國寶(香港)有限公司
香港九龍紅磡暢通道 1 號
中旅貨運物流中心8樓
電話：+852 2333 6249
傳真：+852 2356 9798
電郵：repairs@germanpool.com

Warranty Terms & Conditions

Under normal operations, the product will receive a 1-year full warranty provided by German Pool (effective starting from the date of purchase).

* This warranty is not valid until Customer's registration information is returned to and received by our Service Centre within 10 days of purchase via one of the following methods:

- 1) Visit our website and register online:
www.germanpool.com/warranty.
- 2) Complete all fields on the attached Warranty Card and fax it back to our Customer Service Centre along with the purchase invoice.

1. Customer who fails to present original purchase invoice will be disqualified for free warranty.
2. Customer should always follow the operating instructions. This warranty does not apply to:
 - damages caused by accidents of any kind (including transport and others);
 - operating failures resulted from incorrect voltage, improper operations and unauthorized installations or repairs.
3. This warranty is invalid if:
 - purchase invoice is modified by unauthorized party;
 - product is used for any commercial or industrial applications;
 - product is repaired or modified by unauthorized personnel, or unauthorized parts are installed;
 - serial number is modified, damaged or removed from the product.
4. German Pool will, in its discretion, repair or replace any defective part.
5. This warranty will be void if there is any transfer of ownership from the original purchaser.

Customer Service & Repair Centre

German Pool (Hong Kong) Limited
8/F, China Travel (Cargo) Logistics Centre
1 Cheong Tung Road
Hung Hom, Kowloon, Hong Kong
Tel : +852 2333 6249
Fax : +852 2356 9798
Email : repairs@germanpool.com

此保用只適用於香港

This warranty is valid only in Hong Kong

GERMAN
POOL



德國寶

德國寶 (香港) 有限公司 German Pool (Hong Kong) Limited

中國香港 Hong Kong, China

香港九龍土瓜灣馬頭角道116號
新寶工商中心2期113號室
Room 113, Newport Centre Phase II, 116 Ma Tau
Kok Road, Tokwawan, Kowloon, Hong Kong
電話 Tel: +852 2773 2888
傳真 Fax: +852 2765 8215

中國內地 Mainland China

廣東省佛山市順德區
大良南國東路德順廣場三層
3/F, Takshun Plaza, Nanguo East Road,
Shunde, Foshan, Guangdong
電話 Tel: +86 757 2980 8308
傳真 Fax: +86 757 2980 8318

中國澳門 Macau, China

澳門宋玉生廣場263號
中土大廈15樓1座
Alameda Dr. Carlos D'Assumpcao No. 263,
Edif. China Civil Plaza, 15 Andar, I. Macau
電話 Tel: +853 2875 2699
傳真 Fax: +853 2875 2661



香港 (S MARK)
安全認證



中國櫥櫃/家電行業
十大影響力品牌

CEO

CEO非凡品牌大賞



香港優質商號



香港工商業獎



2007
最具潛質
創建品牌企業獎



香港中小企業
最佳拍檔大獎



香港消費者推展品牌



香港 (G 獎)
優質服務證書



香港最著名牌
HONG KONG
PREMIER BRAND



香港最傑出十年成就獎
Hong Kong Top Brand Ten Year

© 版權所有。未獲德國寶授權，不得翻印、複製或使用本說明書作任何商業用途，違者必究。

© All rights reserved. Copying, reproducing or using the contents of this manual is not allowed without prior authorization from German Pool, violators will be prosecuted.

www.germanpool.com