

GERMAN
POOL



德國寶

光波萬能煮食鍋
Halogen Cooking Pot

CKY-282

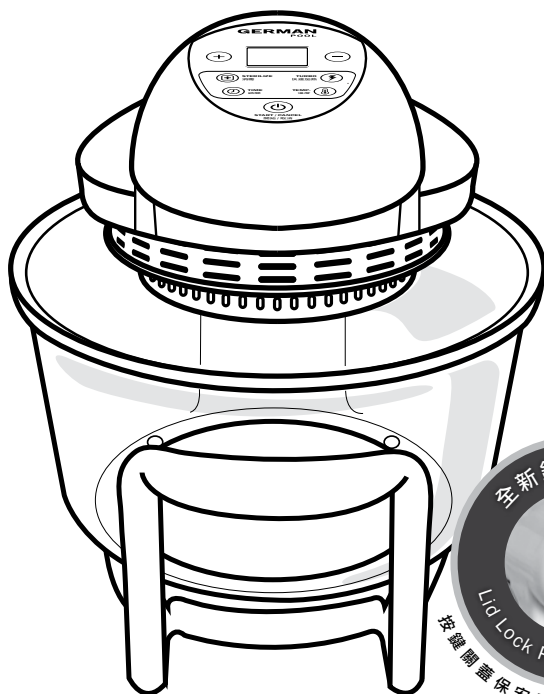

在使用之前請詳細閱讀「使用說明書」及「保用條例」，並妥為保存。
Please read these instructions and warranty information carefully before use and keep them handy for future reference.

CB

使用說明書 OPERATING INSTRUCTIONS

目錄

注意事項	03
產品特點	05
產品結構	06
操作說明	07
清潔與保養	09
配件	10
常見故障及處理	11
技術規格	11
保用條款	23

注意事項

重要說明

- 為安全起見，初次使用產品前請先細閱本說明書，並保存說明書，以便作參考之用。
- 本產品只供家居使用。請必須依照本說明書內的指示操作。

全新鍋蓋安全鎖使用注意

開蓋

- ① 向上打開鍋蓋。
- ② 鍋蓋完全打開後，「鍋蓋安全鎖」會彈出，鍋蓋自動上鎖，以固定位置。

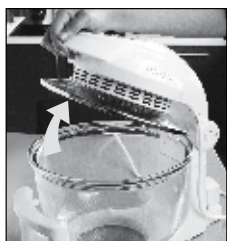

關蓋



- ③ 鍋蓋處於打開狀態時，先將鍋蓋手柄向後拉，然後緊按「鍋蓋安全鎖」。

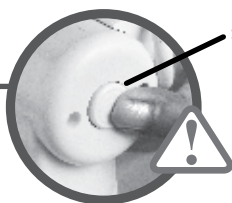

- ④ 繼續緊按「鍋蓋安全鎖」，並同時握著鍋蓋手柄將鍋蓋輕輕放下，直至鍋蓋合上。

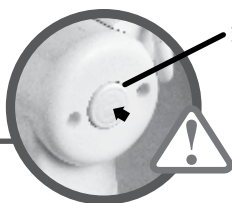

注意：

- 切勿在未按「鍋蓋安全鎖」時用力按下鍋蓋，以免損壞煮食鍋蓋連臂。
- 關蓋時須同時按「鍋蓋安全鎖」及握著鍋蓋手柄，以免鍋蓋撞擊鍋身。

注意事項

1. 請使用專用插座，切勿與其他電器共用電源插頭。
2. 啟動電源前，請先將鍋蓋確實蓋好。
3. 如放在不受熱的桌上使用，必須在本產品下放置隔熱墊才使用。
4. 本產品只供家居及其他相似的室內環境使用，例如：
 - 店舖、辦公室及其他工作場所的員工廚房
 - 農舍
 - 酒店、汽車旅館及其他類型的住所
 - 供住宿及早餐的旅館
5. 本產品並非以外置時間裝置或獨立的遙控器操控。
6. 第一次使用或當玻璃鍋身冷時，可先預熱一下，食物烹煮效果會更佳。
7. 烹調加熱時，切勿碰觸鍋蓋或鍋體，以免燙傷；待玻璃鍋體冷卻後，始可碰觸。請勿讓小孩靠近。
8. 食物必須懸空放置於層架上及不能阻塞風道。
9. 煮食時，不要在容器內放入水或與其他不通風、不耐溫的器皿（如塑膠）共同使用，以免影響烹調效果。
10. 使用完畢後，請立即拔掉電源插頭。
11. 清潔煮食鍋機件前必須先拔下電源，待機件完全冷卻後方可進行。
12. 請勿將鍋蓋直接沖水或泡水清洗，可用扭乾之軟布擦拭污漬，不可用酒精或揮發性物質（如去漬油等）擦拭上鍋蓋。
13. 清洗或烹調時，請避免碰撞玻璃鍋體，以免造成暗傷而導致破裂。
14. 光波爐鍋體與牆壁距離需大於10 cm。
15. 本產品並不適宜讓兒童、身體或心智殘障、缺乏經驗或知識的人士操作，除非該人士得到負責保障其安全的人士的監管或指引。
16. 兒童必須被監督，切勿讓兒童使用、觸摸或把玩本機。
17. 如發現鍋蓋通電後有異聲或較大振動，切勿擅自打開鍋蓋，應先切斷電源，然後立即請專業技術人員或聯絡本公司進行維修。
18. 如電源線損壞或發生其他故障，切勿自行拆卸、修理或改裝，必須由本公司或合資格的專業技術人員更換和維修。
19. 請勿使用受損的電線或電源插頭，以防觸電、引起短路或火災。

產品特點

多功能

德國寶光波萬能煮食鍋能夠代替十多種電器，包括：燒烤爐、傳統焗爐、電飯煲、煮蛋器、電烤箱、多士爐、炖湯煲、麵包機、烘乾機、消毒器、爆谷機、熱狗機等。

無油低脂煮食

以光波萬能煮食鍋來炸薯條、炸薯餅、炸花生、炸腰果、煎魚及醃製任何食品時，均無需加入食油，保證吃得健康。另外，德國寶光波萬能煮食鍋通過光波穿透力，讓食物內的脂肪加速沸騰，逼使油脂加快排出，達到降脂肪的效果。

節能省時

光波萬能煮食鍋運用熱對流、熱傳導及熱穿透三種傳熱方式，從而使烹調速度加快。環型光波管與熱旋系統互相配合，通過圓形玻璃容器的旋流式傳熱，達至更佳節能效果。

絕無油煙

德國寶光波萬能煮食鍋煮食時不會製造油煙或輻射，絕對是入得廚房、出得廳堂的新一代環保電器。

清洗方便

光波萬能煮食鍋能以光波高速旋轉原理分解容器內頑固污漬，自此清潔爐具變得毫無難度。

產品結構

主機身

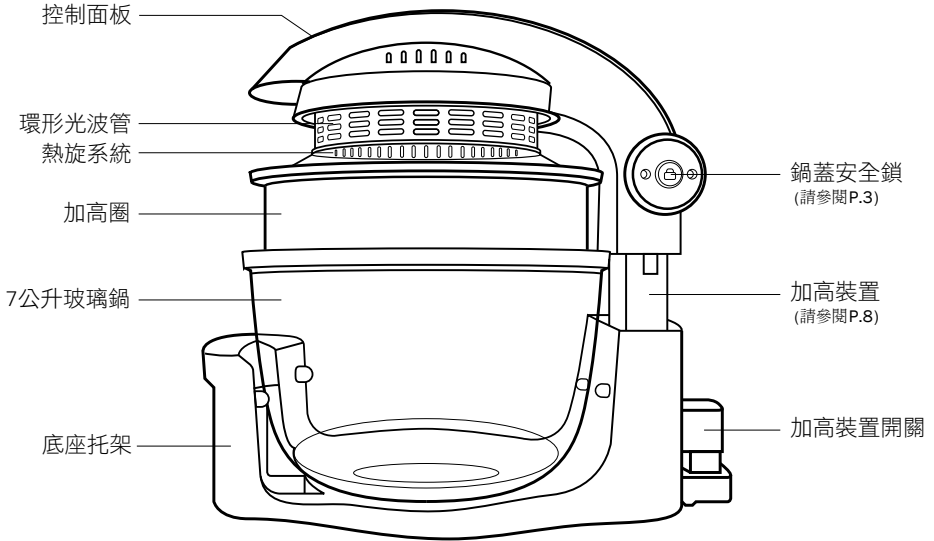

控制面板

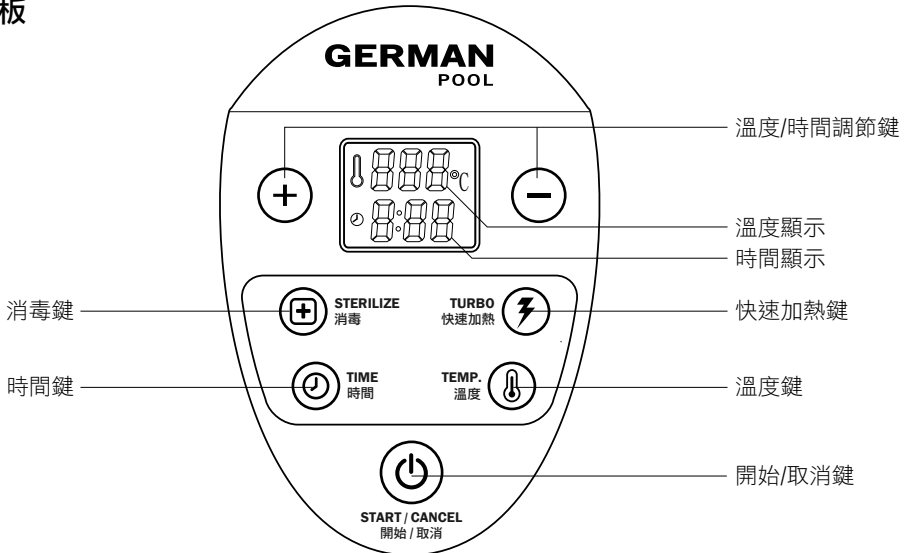

操作說明

注意事項

- 本爐設有安全開關裝置，上蓋掀起時，電源自動關閉；上蓋放平，則繼續運作。
- 如要使用烹調器皿，請使用金屬材質器皿置於層架上，使食物能被全面烘烤而不必翻動，並與鍋蓋保持3厘米以上之距離。
- 使用過程中不可碰觸玻璃鍋，並切勿讓小孩靠近，以免燙傷。

基本操作

1. 底座托架與玻璃容器配合好並水平放置。
2. 請按實際需要自行選擇層架及配件 (請參閱P.10)，放於容器內，再放入食材。
3. 蓋好鍋蓋，接上電源。顯示屏會亮著。
4. a. 自行按照食物種類及份量調校時間（1分鐘-1小時59分鐘）及溫度（50-250°C）。
 - 設定煮食時間：按“⌚ 時間”鍵後，以+/-鍵設定時間，長按+/-鍵可加快設定。
 - 設定煮食溫度：按“🌡 溫度”鍵後，以+/-鍵設定溫度，長按+/-鍵可加快設定。
 - 按“⏻ 開始”鍵開始烹調。
- b. 如選按快速功能鍵“⚡ 快速加熱”或“☀ 消毒”，光波爐會即時開動，以預設時間及溫度運轉，期間可再依個人喜好加以調校。

快速功能鍵	預設時間值/溫度值	功能說明
⚡ 快速加熱	20分鐘/250°C	以最高溫度運作20分鐘
☀ 消毒	13分鐘/130°C	以光波發熱管熱力將食物或食具消毒

註：若光波發熱管在設定時間完結之前熄滅，表示煮食鍋內溫度已達到預設溫度，光波管會暫停加熱程序，但煮食鍋的熱旋系統會繼續運作，直至設定時間完結為止。

5. 完成烹調後（時間顯示為“0:00”），煮食鍋會發出多下聲響以作提示。用戶可拔除電源插頭，打開鍋蓋。
6. 利用取物夾取出食物。

操作說明

暫停煮食

- 若要在運作中暫停烹調，可直接打開鍋蓋，光波管和熱旋系統會同時自動暫停運作，合上鍋蓋則會繼續烹調。
- 如欲在設定時間完結前提早結束烹調，可按“⏻ 取消”，再打開鍋蓋。

鍋蓋安全鎖 (請參閱P.3)

- 向上打開鍋蓋 (圖1)。鍋蓋完全打開後，會自動上鎖，以固定位置。
- 如要合上鍋蓋，請全程緊按“🔒 鍋蓋安全鎖”，同時握著鍋蓋手柄將鍋蓋輕輕放下 (圖2)。



圖1



圖2

加高裝置

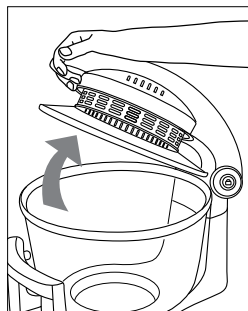
- 向下按住加高裝置開關，同時拉動上蓋至最高位 (圖3)。
- 再在玻璃鍋上放上隨機的加高圈配件，即可增大容量 (圖4)。

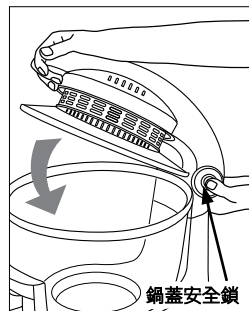

圖3



圖4

注意：

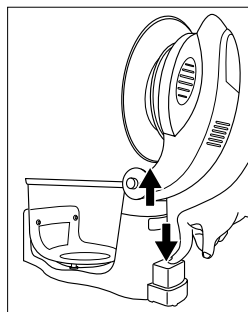
在搬動產品時請勿按加高裝置開關。

錯誤操作

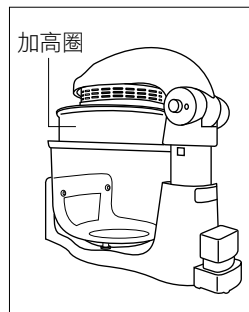
切勿如下列圖示般使用煮食鍋：





操作時用手觸摸鍋蓋及玻璃容器	與其他電器共用電源插頭	操作完畢時，立即在容器內注水

清潔與保養

1. 自動清洗功能：將適量清水(約1/5鍋體高度)注入鍋內，再加入少許中性清潔劑，按“ 快速加熱”，時間設定為10分鐘，即可自動清洗鍋內之油污。
2. 另一清洗方法是直接將玻璃鍋拆下，以海綿沾少許中性清潔劑，輕輕刷洗鍋身。
3. 如使用洗碗碟機，先將玻璃鍋拆下，將玻璃鍋及層架放入洗碗碟機清洗。切勿將上鍋蓋放入洗碗碟機。
4. 清潔煮食鍋機件前必須先拔下電源，待機件完全冷卻後方可進行。
5. 清洗時，請避免碰撞玻璃鍋體，以免造成暗傷而導致破裂。
6. 上鍋蓋因含電子部件，切勿用水浸泡清洗，玻璃鍋蓋請以扭乾的軟布抹拭即可。
7. 清潔容器、托架或配件時，可用含有溫和洗潔精的水進行清潔，但切勿於高溫中進行。
8. 清洗完畢後，以乾布拭乾鍋身及鍋蓋部位。

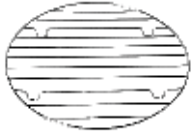
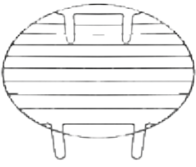
配件

隨機配件

<p>低架</p> 	<p>高架</p> 	<p>取物夾</p> 
<p>適用於烹調較大型的食物 如：烤鴨、烤雞、燉湯、煲仔飯。</p>	<p>適用於需靠近發熱體的食物，或配合 低架進行雙層煮食 如：串燒、叉燒、豬頸肉、雞翼。</p>	<p>用以取出器皿或食物，以防燙手。</p>
<p>加高圈</p> 	<p>煎碟</p> 	<p>烘盤</p> 
<p>用以增大容量3公升，尤其適用於 烤鴨、烤雞及多層煮食。</p>	<p>適用於煎餃子、煎魚、腸粉及 其他食物。</p>	<p>適用於烘焙細小的食物 如：花生、薯條、藥材、曲奇餅等。</p>

自選配件

<p>廚寶</p> 
<p>適用於焗飯、煲仔飯、焗蛋糕、 湯、麵等。</p>

常見故障及處理

如遇以下一般性故障，請按以下指示處理，如仍處理不了或未發現故障原因時，請與本公司維修服務中心聯繫。

注意：為安全著想，再次特別提醒，請勿自行拆卸修理。

故障現象	處理方法
首次使用光波爐時出現冒煙情況。	- 於首次使用時，先以最高溫250°C空烤5分鐘，從而將機件保護油脂完全揮發出來。
光波爐不運作。	- 檢查插頭是否已妥為插入插座和機身。 - 確認上蓋已完全放下至水平位置。 (註：上蓋掀起時，電源會自動關閉。)
光波爐不加熱。	- 檢查是否已調至較高的所需溫度。
完成烹調，摩打風扇仍然轉動。	- 此乃為了散熱，當溫度降至100°C以下，風扇摩打便會自動停止。
鍋蓋或玻璃鍋破損。	- 於本公司維修服務中心更換。

技術規格

型號	CKY - 282
電壓	220-240 V
頻率	50 Hz
功率	1,000 W
溫度調節範圍	50 - 250 °C
時間控制範圍	0 - 1 hr 59 min
煮食鍋尺寸 (連底座)	(H) 320-322 mm (W) 275-277 mm (D) 405 mm
玻璃容器尺寸	(H) 170-172 mm (Ø) 275-277 mm
容器容量	7 (+3) L
淨重	5.2-5.8 kg

中英文版本如有出入，一概以中文版為準。

Table Of Contents

Notice Before Use	13
Product Features	15
Product Structure	16
Operating Instructions	17
Care & Maintenance	19
Accessories	20
Troubleshooting	21
Technical Specifications	22
Warranty Terms & Conditions	23

Notice Before Use

Important

- For safety purpose, you should read the instructions carefully before using the appliance for the first time. Save the instructions for future reference.
- The appliance is designed for domestic use and may only be operated in accordance with these instructions for use.

New Safety Feature: Lid Lock Protection Button Operating Guide

Opening the lid

- ① Pull up to open the lid.
- ② When the lid is fully open, Lid Lock Protection Button will pop out. The lid will be locked at the open position.

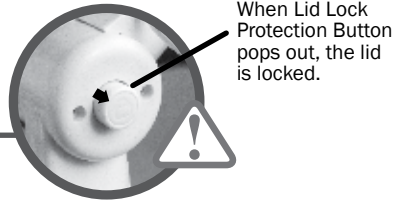

Closing the lid



- ③ When the lid is at the open position, pull the lid handle backwards. Then press and hold Lid Lock Protection Button.

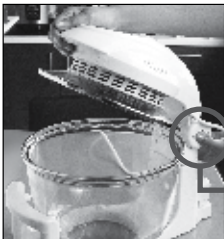
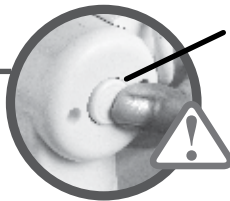

- ④ Continue to hold Lid Lock Protection Button, and simultaneously grasp the lid handle to gently close the lid.

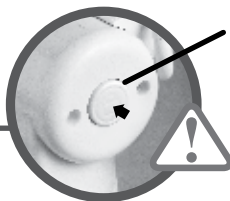

Attention:

- Do not force the lid to close without pressing Lid Lock Protection Button to avoid damaging the lid arm.
- Grasp the lid handle firmly while pressing Lid Lock Protection Button to avoid crashing the pot.

Notice Before Use

1. Use a separate plug for the appliance. Do not overload power socket.
2. Before turning on the appliance, make sure it is plugged in and the lid is closed.
3. If the appliance is operated on a non-heat resistant table, place a heat-proof mat under the appliance before use.
4. This appliance is intended to be used in household and similar applications such as:
 - staff kitchen areas in shops, offices and other working environments;
 - farm houses;
 - hotels, motels and other residential type environments;
 - bed and breakfast type environments.
5. This appliance is not intended to be operated by means of an external timer or a separate remote-control system.
6. When using the pot for the first time or when the glass container is cool, preheating will help to deliver better cooking results.
7. Do not touch the glass container during operation. Keep children away from the unit to prevent injuries.
8. Food must be placed on a rack inside the glass container. Make sure there is space between food and heating element, and interior airflow circulation should not be blocked.
9. Do not put water or plastic containers inside cooking pot during operation.
10. Unplug the cooking pot after use.
11. Unplug power cord and cool down cooking pot before cleaning or washing.
12. Wipe cooking pot cover with a soft and dry cloth. Do not rinse it with water. Do not clean it with alcohol or VOCs.
13. Avoid any form of tapping, knocking or striking against cooking pot in order to avoid damages.
14. There should be a distance of 10 cm between the appliance and the wall.
15. The appliance is not intended for use by persons (including children) with reduced physical, sensory or mental capabilities, or any individual lacking experience and knowledge unless they have been given supervision or instruction by a person responsible for their safety.
16. Children should be supervised to ensure that they do not play with the appliance.
17. When strange noise is heard or severe vibration occurs, do not open cooking pot cover. Unplug power immediately, and contact the manufacturer or a licensed technician for repair.
18. If the power cord is damaged, it must be replaced by the manufacturer, its service agent or similarly qualified persons in order to avoid a hazard.
19. Do not attempt to disassemble, repair or modify the appliance.

Product Features

Multiple Functions

Due to a wide operating temperature range (50-250 °C), German Pool Multi-Purpose Halogen Cooking Pot can function as an electric grill, rice cooker, conventional oven, microwave oven, toaster, stewing pot, sterilizer, skillet, bread maker, egg maker, steamer, popcorn maker, etc.

Healthy Cooking

When using Multi-Purpose Halogen Cooking Pot, no oil is needed during the preparation and cooking process. Heat waves produced by its halogen heating element can penetrate directly into meat. Through heating animal fat inside meat, Halogen Cooking Pot effectively drives out fats and reduces grease within food. Thus cholesterol content can be lowered to the minimum.

Time- & Energy-Efficient

Multi-Purpose Halogen Cooking Pot transfers heat to food by means of convection, conduction and penetration all at once. As a result, food can be cooked within a much shorter time.

Owing to its circular heating element together with the patented internal venting system, German Pool Halogen Pot can deliver heat directly to food from all directions inside the glass container. Tests have shown that it saves electricity up to 20% compared to conventional ovens.

No Mess

With German Pool Multi-Purpose Halogen Cooking Pot, there is no more open-flame nor greasy smoke in the kitchen. User can even cook and serve right at the dining table without making a mess thanks to the detachable glass container/plastic base design.

Simple Cleaning

Thanks to its high speed heat circulation, German Pool Multi-Purpose Halogen Cooking Pot can automatically decompose tough stains and grease within minutes.

Product Structure

Unit Body

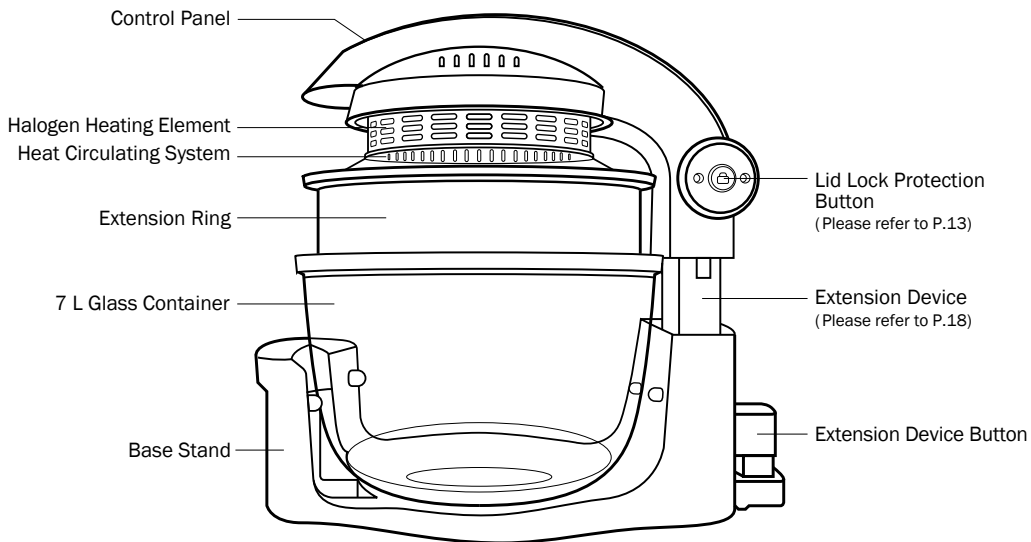

Control Panel

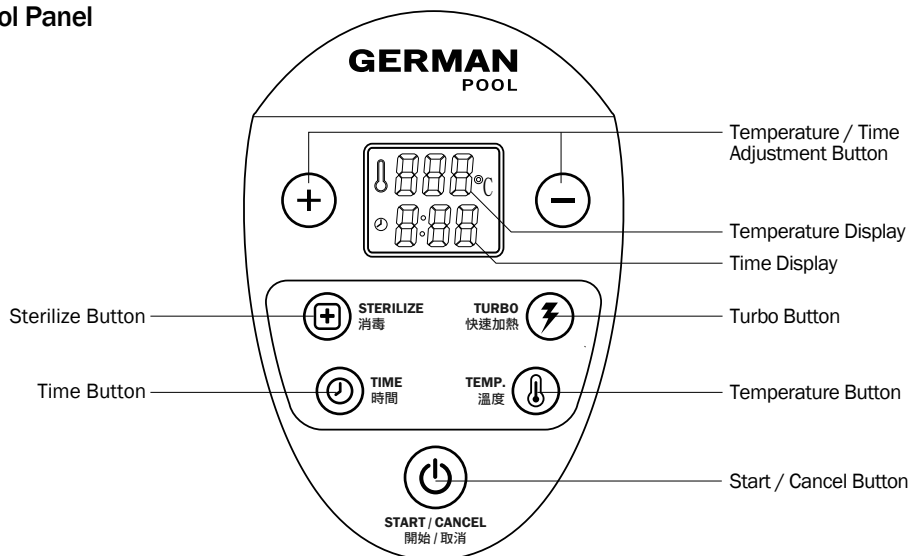

Operating Instructions

Attention

- As a safety measure, when the lid is open, heating element and fans will be switched off. When it is placed down, the unit will continue its operation.
- If a cookware is to be used inside glass container, use one that is made of metal and place it on a rack to ensure that food is evenly cooked. There should be a distance of at least 3 cm between the food and the lid.
- Do not touch the glass container during operation. Keep children away from the unit to prevent injuries.

Basic Operation

1. On a flat and level surface, attach glass container to plastic base stand.
2. Select appropriate rack and accessories based on food type and style of cooking (please refer to P.20). Position rack in glass container and place food items on top of the rack.
3. Secure pot cover. Then plug in power.
- 4 a. Set cooking time (1 min - 1hr and 59 min) and temperature (50-250°C).
 - Press “⌚ TIME” and then press “+” or “-” to select cooking time.
 - Press “🌡️ TEMP.” and then press “+” or “-” to select temperature.
 - Press “🔴 START” to start.
- b. If you press the one-touch function keys “⚡ TURBO” or “☺️ STERILIZE”, the unit will operate immediately. The cooking time and temperature can be adjusted during cooking.

One-touch Function	Default Time/Temp.	Details
⚡ TURBO	20 min / 250°C	Press to operate cooking pot at the highest temperature setting for 20 minutes.
☺️ STERILIZE	13 min / 130°C	Press to heat food or utensils for sterilizing purposes.

Note:

Heating element may go off before set time is up. It means that the desired temperature is reached. Cooking pot would temporarily stop adding heat. However, the heat circulating system would keep on running until time is completely over.

5. When time is over (“0:00”), cooking pot will beep several times. Unplug power and lift up cooking pot cover.
6. Take food or plate out of glass container using the supplied plate lifter.

Operating Instructions

Pause Function

- Before set time is up, user can pause operation by simply lifting up the pot cover and resume cooking by closing it.
- To end cooking pot's operation before time is up, press “ CANCEL” and then lift up pot cover. Time and temperature settings will be erased.

Lid Lock Protection Button (See P.13)

- Pull up to open the lid (Fig 1). The lid will be locked at the open position when it is fully open.
- To close the lid, press and hold the “ Lid Lock Protection Button” and simultaneously grasp the lid handle to close (Fig 2).

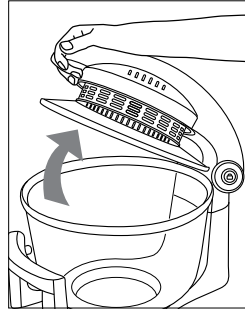

Fig 1

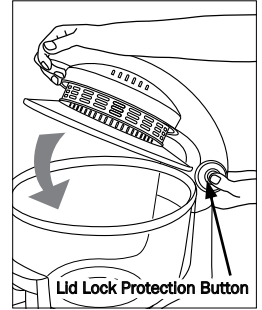

Fig 2

Extension Device

- Press the Extension Device Button downward to release the lock and lift the lid to expanded position (Fig 3).
- Place the Extension Ring on top of the glass pot, in order to increase the capacity (Fig 4).

Note:

Do not press the Extension Device Button when moving or holding the product.

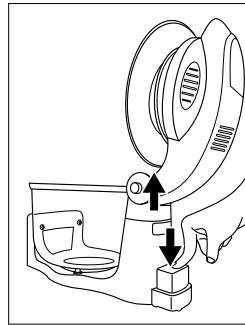

Fig 3

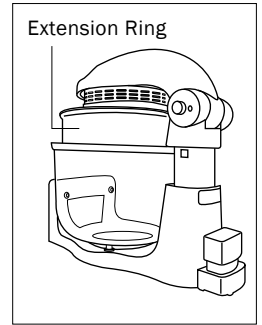

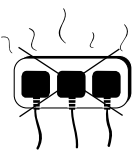



Fig 4

Incorrect Operation

Please do NOT :



		
Touch cooking pot cover or glass container with hand during operation.	Overload power socket.	Pour water into container immediately after operation.

Care & Maintenance

1. To use the auto-cleaning function: Fill water up to 1/5 of the glass container. Add in mild detergent. Press “  TURBO” button and set time to 10 min.
2. Another method is to remove the glass container and use a sponge with mild detergent to wipe it clean.
3. If you wish to use a dishwasher, remove the glass container from its stand before dishwashing. Wash glass container and racks in the dishwasher, but do not wash the lid in a dishwasher.
4. Unplug power cord and cool down cooking pot before cleaning or washing.
5. While cleaning the cooking pot, avoid any form of tapping, knocking or striking against it, in order to avoid damages.
6. Since cooking pot cover comprises of electrical parts, do not immerse or rinse it with water. Wipe the cover with a soft and dry cloth.
7. Clean glass container, base stand and supplied accessories with mild detergent; cool down the entire cooking pot before any cleaning procedure.
8. After cleaning, wipe the glass container and pot cover with a dry cloth.

Accessories

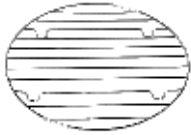
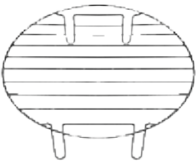
Supplied Accessories

<p>Low Rack</p>  A circular metal rack with horizontal bars and a central support.	<p>High Rack</p>  A circular metal rack with horizontal bars, a central support, and four legs.	<p>Plate Lifter</p>  A metal plate lifter with a handle and a support.
<p>For larger food items such as Grilled Duck, Grilled Chicken, Casserole, etc.</p>	<p>Allows food to be placed near heat source, e.g. Skewers; can be used simultaneously with low rack for multi-level cooking.</p>	<p>To carry food or plate in and out of cooking pot.</p>

<p>Ring Extension</p>  A metal ring extension for a cooking pot.	<p>Frying Pan</p>  A black frying pan.	<p>Baking Pan</p>  A metal baking pan with a perforated surface.
<p>To increase cooking pot capacity by 3 L. Ideal for Grilled Duck, Grilled Chicken and multi-level cooking.</p>	<p>For Gyoza Dumplings, Fish, etc.</p>	<p>For baking small items such as Nuts, French Fries, Chinese Herbs, Cookies, etc.</p>

Optional Accessory

<p>Casserole Pot With Cover</p>  A black casserole pot with a lid.
<p>For Rice, Noodles, Soup, etc.</p>

Troubleshooting

If you encounter the following common troubles, please solve according to the following instructions. If the problem cannot be solved or a cause cannot be found, please contact our customer services centre.

Note: For safety purpose, do not dismantle the product for repair by yourself.

Phenomenon	Solution
Smoke is given out when using cooking pot for the first time.	- Operate at the highest temperature 250°C for 5 min without putting in food at the first time, for the protective grease to evaporate.
Cooking pot cannot be turned on.	- Check whether the power cord is properly plugged to both the socket and the unit body. - Secure the lid by placing it down. (Note: When the lid is not completely closed, the appliance will not turn on.)
Cooking pot does not heat up.	- Check whether the appliance is set to operate at a high enough temperature.
Motor still operates after cooking.	- The purpose is to cool down the appliance. The fan will stop operating after the temperature falls below 100 °C.
Lid or glass container is cracked.	- Order replacement at German Pool customer services centre.

Technical Specifications

Model	CKY-282
Voltage	220-240 V
Frequency	50 Hz
Power	1,000 W
Thermostat	50-250 °C
Timer	0-1 hr 59 min
Cooking Pot Dimension (With Base Stand)	(H) 320-322 mm (W) 275-277 mm (D) 405 mm
Container Dimensions	(H) 170-172 mm (Ø) 275-277 mm
Capacity	7 (+3) L
Net Weight	5.2-5.8 kg

If there is any inconsistency or ambiguity between the English version and the Chinese version, the Chinese version shall prevail.

請填妥以下空格並與發票一併保存，以便維修時核對資料。用戶提供本公司之所有資料必須正確無誤，否則免費保用將會無效。
Please fill out the form below. This information and the purchase invoice will be required for any repairs. Warranty will be invalid if information provided is found to be inaccurate.

型號 Model No. : CKY-282

機身號碼 Serial No. : _____

發票號碼 Invoice No. : _____

購買商號 Purchased From : _____

購買日期 Purchase Date : _____

保用條款

此保用提供德國寶產品之機件在正常使用下壹年保用(自購買日起計算)。

* 貴戶須在購機十天內，以下列其中一種方式向本公司登記資料，保用手續方正式生效：

- 1) 填妥本公司網頁內之保用登記表格 www.germanpool.com/warranty。
- 2) 填妥保用登記卡，並連同購機發票之副本一併郵寄到客戶服務部 (本公司將不發還發票副本或登記卡)。

1. 未能出示購買發票正本者，將不獲免費維修服務。
2. 用戶應依照說明書的指示操作。本保用並不包括：
 - 上門安裝、檢驗、維修或更換零件之人工以及一切運輸費用；
 - 因天然與人為意外造成的損壞 (包括運輸及其他)；
 - 任何塑膠附件及輔助裝置；
 - 電源接合不當、不依說明書而錯誤或疏忽使用本機所引致之損壞。
3. 於下列情況下，用戶之保用資格將被取消：
 - 購買發票有任何非認可之刪改；
 - 產品被用作商業或工業用途；
 - 產品經非認可之技術人員改裝或加裝任何配件；
 - 機身編號被擅自塗改、破壞或刪除。
4. 總代理有權選擇維修或更換配件或其損壞部份。
5. 產品一經被轉讓，其保用即被視作無效。

維修部 - 小型電器

德國寶(香港)有限公司
香港九龍紅磡暢通道 1 號
中旅貨運物流中心8樓
電話：+852 2215 4582
傳真：+852 2355 7100
電郵：repairs@germanpool.com

Warranty Terms & Conditions

Under normal operations, the product will receive a 1-year full warranty provided by German Pool (effective starting from the date of purchase).

* This warranty is not valid until Customer's registration information is returned to and received by our Service Centre within 10 days of purchase via one of the following methods:

- 1) Visit our website and register online: www.germanpool.com/warranty.
- 2) Complete all fields on the attached Warranty Card and mail it back to our Customer Service Centre along with a photocopy of the purchase invoice (Warranty Card and invoice copy will not be returned to Customer).

1. Customer who fails to present original purchase invoice will be disqualified for free warranty.
2. Customer should always follow the operating instructions. This warranty does not apply to:
 - labour costs for on-site installation, check-up, repair, replacement of parts and other transportation costs;
 - damages caused by accidents of any kind (including transport and others);
 - plastic parts and accessories;
 - operating failures resulted from incorrect voltage, improper operations and unauthorized installations or repairs.
3. This warranty is invalid if:
 - purchase invoice is modified by unauthorized party;
 - product is used for any commercial or industrial applications;
 - product is repaired or modified by unauthorized personnel, or unauthorized parts are installed;
 - serial number is modified, damaged or removed from the product.
4. German Pool will, in its discretion, repair or replace any defective part.
5. This warranty will be void if there is any transfer of ownership from the original purchaser.

Repair Centre - Small Appliances

German Pool (Hong Kong) Limited
8/F, China Travel (Cargo) Logistics Centre
1 Cheong Tung Road
Hung Hom, Kowloon, Hong Kong
Tel : +852 2215 4582
Fax : +852 2355 7100
Email : repairs@germanpool.com

此保用只適用於香港

This warranty is valid only in Hong Kong

GERMAN
POOL



德國寶

德國寶 (香港) 有限公司 German Pool (Hong Kong) Limited

中國香港總代理 Hong Kong, China Sole Agent

九龍土瓜灣馬頭角道116號新實工商中心高層地下2-4號室
Room 2-4, Upper G/F, Newport Centre, 116 Ma Tau Kok Road,
Tokwawan, Kowloon

電話 Tel: +852 2333 6245 傳真 Fax: +852 2765 8215

中國內地總代理 Mainland China Sole Agent

廣東省佛山市順德區南國東路永旺(吉之島)購物中心3樓
3/F, Yongwang (Jusco) Shopping Mall, Nanguo East Road,
Shunde, Foshan, Guangdong

電話 Tel: +86 757 2980 8308 傳真 Fax: +86 757 2980 8318



© 版權所有。未獲德國寶授權，不得翻印、複製或使用本說明書作任何商業用途，違者必究。

© All rights reserved. Copying, reproducing or using the contents of this manual is not allowed without prior authorization from German Pool, violators will be prosecuted.

www.germanpool.com