

GERMAN
POOL

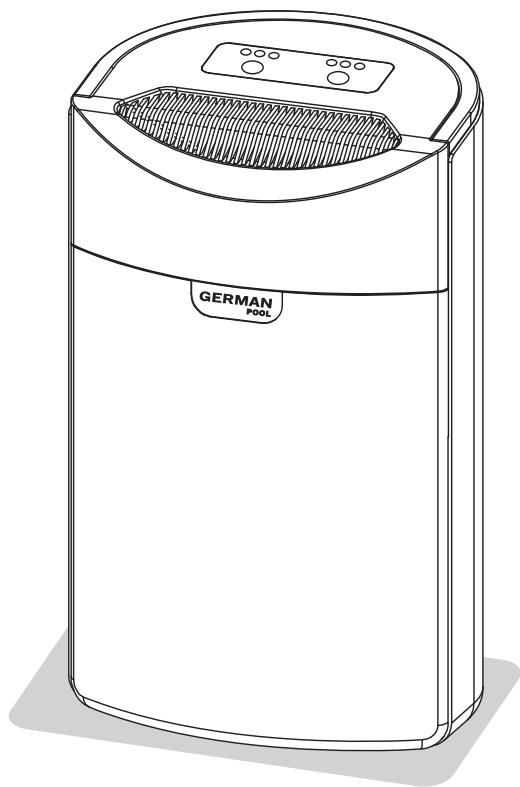

德國寶

抽濕機 | DHM-406
Dehumidifier



在使用之前請詳細閱讀「使用說明書」及「保用條例」，並妥為保存。

Please read these instructions and warranty information carefully before use and keep them handy for future reference.



使用說明書 OPERATING INSTRUCTIONS

請即進行保用登記!

有關保用條款細則，請看本說明書最後一頁。

Please register your warranty information now !

For Warranty Terms & Conditions,

please refer to the last page of these operating instructions.

目錄 Table of Contents

注意事項 Notice Before Use 04

產品結構 Product Structure 05

操作說明 Operating Instructions 07

清潔與保養 Care & Maintenance 10

常見故障及處理 Troubleshooting 11

安全注意事項 Safety Cautions 12

技術規格 Technical Specifications 13

保用條款 Warranty Terms & Conditions 15

注意事項 Notice Before Use

重要說明

為安全起見，初次使用產品前請先細閱本說明書，並保存說明書，以便作參考之用。

本產品只供家居使用。請必須依照本說明書內的指示安裝及操作。

1. 在清潔或儲存抽濕機時請先將插頭拔下。
2. 拔出電源插頭前應先按電源鍵關掉本機。
3. 請勿將本機浸在水中或接近水源。
4. 請勿將本機放置在靠近發熱裝置或易燃危險品處。
5. 請勿將手指或棒狀物件插入進風口或出風口處。
6. 請勿坐立在此機台上。
7. 請按照要求將水箱進行排水。
8. 請確保排水管往下安裝，以便冷凝水可持續地排出。
9. 機身應保持水平，避免放置本機於不平或傾斜的地面。
10. 切勿用水噴灑本機。
11. 切勿於本機上噴灑殺蟲劑及可燃性液體。
12. 請勿於本機上放置重物或讓小孩、動物乘坐。
13. 本機不得於密閉狹窄的空間裡操作。
14. 電源線損壞時，必須由本公司認可或合資格之技術人員進行更換。
15. 電壓與頻率應與本機之技術規格相符。
16. 當抽濕機運作時，確保其四周的最小間距如下圖所示：

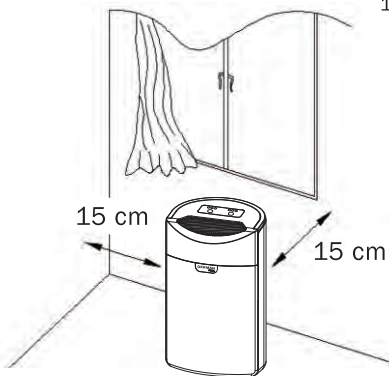

Important

For safety purpose, you should read the instructions carefully before using the appliance for the first time. Save the instructions for future reference.

The appliance is designed for domestic use and may only be installed and operated in accordance with these instructions for use.

1. Unplug the power supply cord before cleaning or storage.
2. Always press Power button to turn off the unit before unplugging.
3. Do not immerse the unit in water, or place it close to water.
4. Do not put the unit close to heat-generating devices or near flammable and dangerous materials.
5. Never put your fingers or any stick-form objects into the air inlet or outlet grille.
6. Do not sit or stand on the unit.
7. Discard water collected in the tank as instructed.
8. Install drain piping at a downward direction to make sure that condensed water can be drained continuously.
9. Place and operate the unit on a stable and level floor.
10. Do not spray or splash water directly onto the unit.
11. Do not spray any pesticide nor flammable liquid onto the unit.
12. Do not place any heavy object or let children and pets sit on the unit.
13. Do not operate dehumidifier in a small and confined space.
14. Damaged power cord must be replaced by a licensed technician.
15. Power voltage and frequency should accord with the main technical parameter requirement of the unit.
16. Maintain the below minimum clearance around the dehumidifier during operation:

產品結構 Product Structure

機身 Body

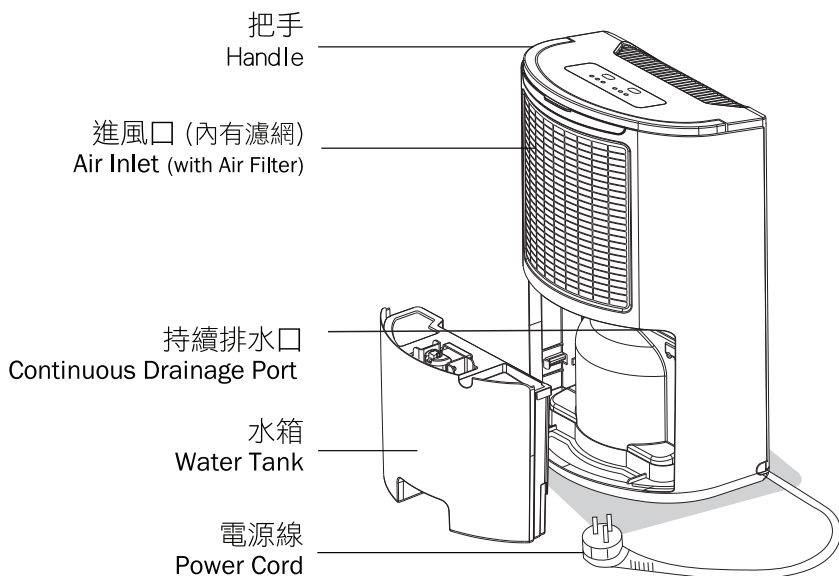
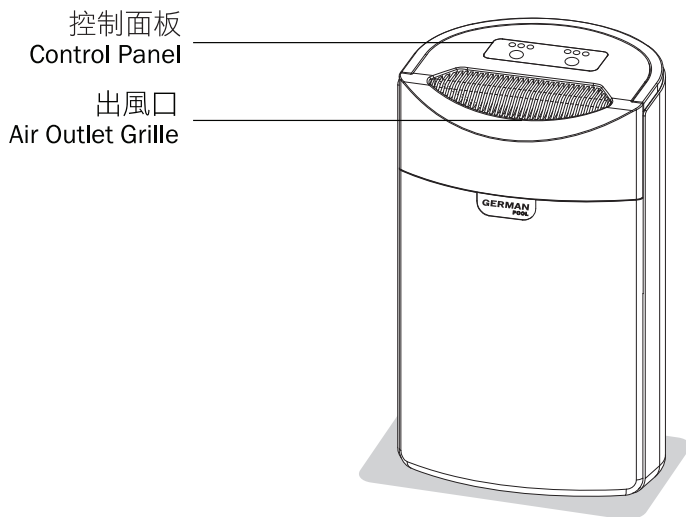

產品結構 Product Structure

操作面板

Control Panel

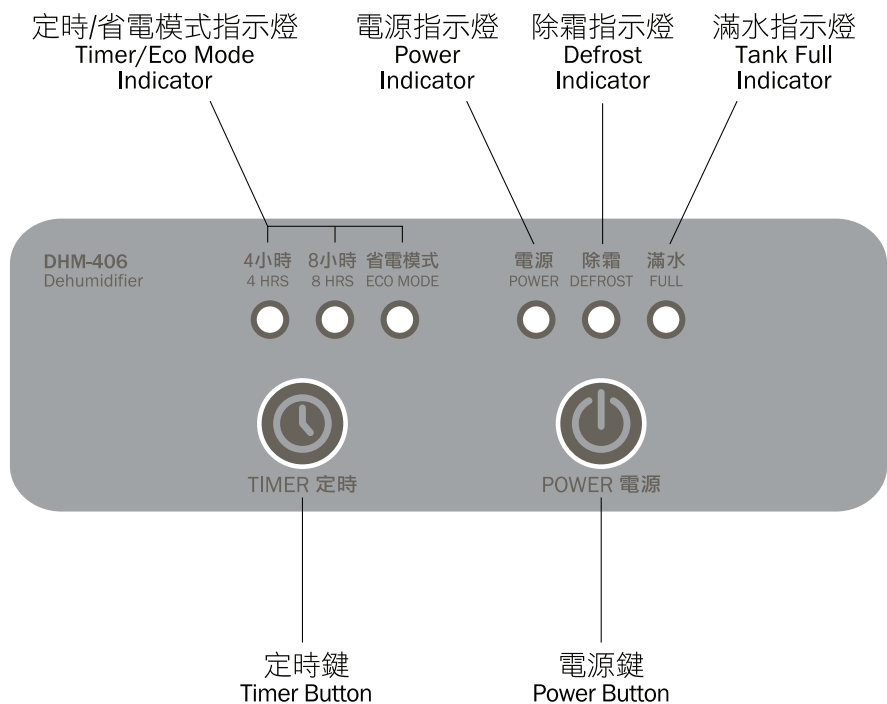





操作說明 Operating Instructions

A. 基本操作步驟

註：

啟動本機前請確保出風口不被遮蓋，否則本機會出現過熱危險。

1. 插上電源插頭。
2. 按電源鍵  啟動本機。電源指示燈會亮起。
3. 定時功能
 - a. 按定時鍵  選擇4 / 8小時運轉時間，定時指示燈會亮起。若關機再開時，定時功能會記憶關機前的設定。
 - b. 可按定時鍵  選擇省電模式，本機每運轉45分鐘會暫停15分鐘，直至關機或滿水停機。
4. 當水箱滿水時，滿水指示燈亮起，本機會自動停止運作。請取出水箱倒水後，再放回水箱，本機便會再次運作。
5. 當除霜指示燈亮起，表示環境溫度太低而使機器內部有結霜現象，此時機體會進行自動除霜之程序。
6. 若要停止使用機器，按電源鍵  即可。

* 如長時間不使用抽濕機時，請拔下電源線插頭。





註：

- 本機適用溫度範圍為5°C - 32°C。在此範圍外使用，機體會自動啟動開關保護裝置，使機體自動停止運轉，此為正常現象。
- 室溫在5°C以下時，環境的絕對濕度相當低，基本上可以不必使用抽濕機。

A. Basic Operation

Note:

Before you start the unit, make sure that the air outlet grille is not blocked. Otherwise, the unit may be overheated.

1. Plug in the unit.
2. Press Power button  to start the operation.
3. Timer Function:
 - a. Press Timer button  to set the operating time (4 / 8 hours). Timer indicator will light up. The set time will be kept for next operation if the unit is turned off.
 - b. You may press Timer button  to select ECO mode for energy saving purpose. The unit will operate for 45 minutes and then stop running for 15 minutes. This process will continue until the unit is off.
4. When "FULL" indicator lights up, the unit will stop running. Detach the water tank and pour out the water. When the water tank is placed back, the unit will start to operate again.
5. When "DEFROST" indicator lights up, the unit is in defrost mode. The light will go off when the defrost process is complete.
6. Press Power button  once again to turn off the unit.

* Please unplug the unit when it is not intended to be used for an extended period of time.

Note:

- The operating temperature range is from 5°C to 32°C. The machine may periodically stop operating outside this range for safety reason.
- Dehumidification is not necessary when room temperature is below 5°C.

操作說明 Operation Instructions

B. 水箱排水

當水箱水滿時，水滿指示燈會亮起紅色，並自動停機。此時必須清空水箱中的水。

B. Water Drainage

When the water tank is full, the Tank Full indicator will light up, the operation will stop automatically. Empty the water from the water tank when this happens.

清空水箱

Emptying the Water Tank

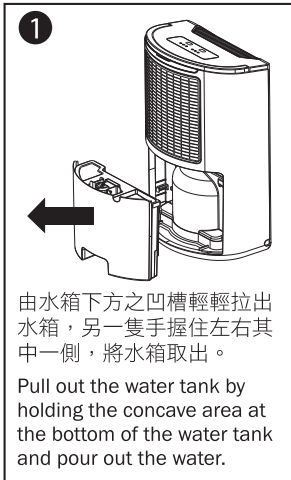

註：

- 請勿將水箱中的浮子移走，如果水箱的浮子被移走之後，水滿感應器將無法正常感應到水位，以致呈現滿水停機狀態。
- 請勿將物品置於水箱中，以致浮子卡住，否則可能導致水滿時水會從水箱中溢出。
- 如果水箱很髒，只需使用冷水或溫水清洗即可，不可使用清潔劑、鋼絲絨、化工處理的除塵布、汽油、苯、稀釋劑或其他溶劑處理，否則可能會損壞水箱致使其漏水。
- 當放入水箱時，用雙手將水箱按緊，如果水箱沒有放置好，水滿感應器仍然會被啟動，抽濕機將無法運轉。

Note:

- Do not remove the float from the water tank. The water full sensor will no longer be able to detect the water level correctly without the float and the unit will stop to operate.
- Do not put any object into the water tank. This will lead to malfunction of the float and water leakage when water tank is full.
- If the water tank is dirty, wash it with cold or lukewarm water. Do not use detergent, scouring pads, chemically treated dust cloths, gasoline, benzene, thinner, or other solvents, as these can scratch and damage the tank and cause water leakage.
- When replacing the water tank, press the tank firmly into place with both hands. If the tank is not positioned properly, the "Tank Full" sensor will still be activated, and the dehumidifier will not operate.

操作說明 Operation Instructions

持續性排水

Continuous Drainage

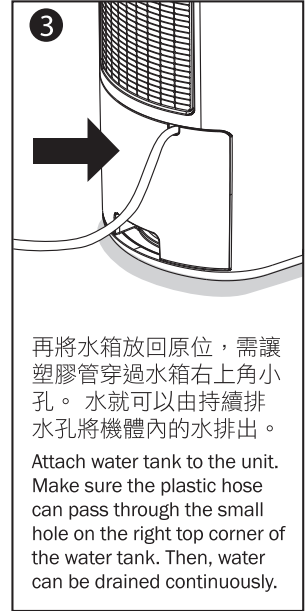
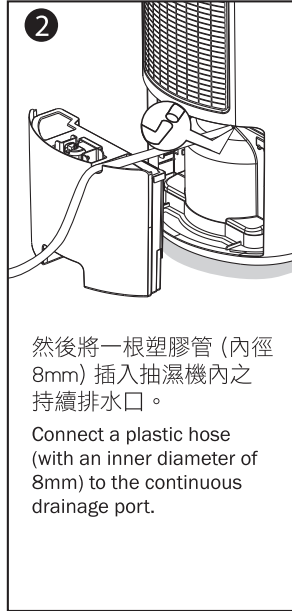

清潔與保養 Care & Maintenance



警告

為免觸電，在清潔與維修前必須關掉本機，並拔除電源插頭。



Caution

In order to avoid electric shocks, please power off the machine and pull out the plug before cleaning or repair.

A. 機身清洗

採用柔軟微濕的布擦拭機身。

A. Cleaning the body

Wipe the unit body with a soft damp cloth.

B. 過濾網清洗

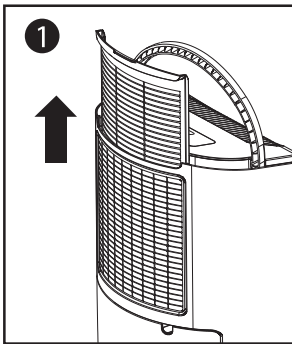

1. 拉起濾網。

2. 清洗濾網：使用吸塵器輕輕地吸走濾網表面的灰塵，如果濾網非常髒，可使用溫水及柔和的清潔劑擦拭並完全晾乾。建議約每周清洗一次，以保持高除濕效率。

3. 將濾網慢慢地插回機身。

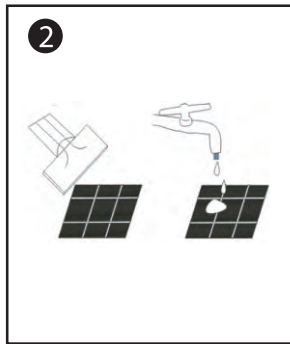

B. Cleaning the Filter

1. Pull up to remove the air filter.

2. Cleaning: Run a vacuum cleaner lightly over the surface of air filter to remove dirt. If the air filter is exceptionally dirty, wash it with warm water and a mild cleanser and dry thoroughly. To maintain high dehumidifying efficiency, it is suggested to clean the filter approx. once a week.

3. Insert the filter into the unit smoothly.

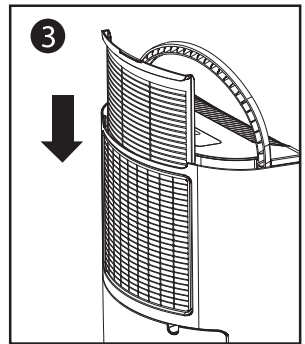

C. 抽濕機儲存

長時間不使用抽濕機而想將其存放時，注意以下步驟：

1. 清空水箱內的積水。

2. 將電源插頭拔下。

3. 放置數小時使機內完全乾燥後，將電源線放置於水箱內，直立收藏於清爽乾燥的環境中。

C. Dehumidifier Storage

When the unit is not being used for a long time and you want to store it, please follow the steps below:

1. Empty any water left in the water tank.

2. Unplug the unit and keep the power cord at the back of the unit.

3. Leave it for a few hours to wait till its interior is completely dry and put the power cord into the water tank. Then store it in a cool and dry place.

常見故障及處理 Troubleshooting

使用中如發現本機操作上有問題，請依照下表進行檢查。

When you run into any problems operating this product, use the table below to troubleshoot the problems.

故障現象 Phenomenon	原因分析 Possible Cause	處理方法 Solution
機器不運轉。 The unit does not operate.	電源線是否有正常連接好? Has the power cord been disconnected?	將插頭和插座連接好。 Plug the power cord into the outlet.
	滿水指示燈有亮著嗎? (水箱水滿或未放到位) Is the Tank Full indicator blinking? (The tank is full or in a wrong position.)	將水箱中的水排出並將其放回機身的正確位置。 Empty the water in the water tank and then reposition the tank.
	室溫是否在32°C之上或5°C之下? Is the room temperature above 32°C or below 5°C	因本產品並不適用於過熱或過冷的環境，保護裝置啟動，因此機器暫時不工作。 This product is not designed to be used in an environment too cold or too hot. The protection device is activated and the unit cannot be started temporarily.
抽濕功能無法啟動。 The dehumidifying function does not work.	濾網是否被阻塞? Is the air filter clogged?	按照“清潔及保養”一欄將濾網清洗乾淨。 Clean the air filter as instructed under “Care & Maintenance”.
	入風口或出風口是否被堵塞了? Is the air inlet or air outlet obstructed?	將阻塞物從入風口或出風口清除。 Remove the obstruction from the air inlet or outlet.
運轉時噪音大。 Operation is noisy.	機器是否傾斜放置? Is the unit tilted or unsteady?	將機器移放至水平，穩固機器位置。 Move the unit to a stable and sturdy location.
	濾網是否被阻塞? Is the air filter clogged?	按照“清潔及保養”一欄將濾網清洗乾淨。 Clean the air filter as instructed under “Care & Maintenance”.

注意：如問題持續發生，請關機及拔除電源插頭，並送回本公司維修。

Note: If the problem persists or other abnormal situations occur, turn off the machine and pull out the plug. Then contact our Repair Centre for help.

安全注意事項 Safety Cautions



1. 使用時，請勿將本機置於柔軟、不平地面上，避免產生震動或移動。

Do not place unit on uneven surface.

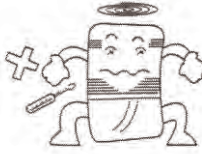

2. 不可使用細棒、硬物插入機身內，以免發生故障或危險。

Do not insert any sharp objects into air inlet/air outlet.

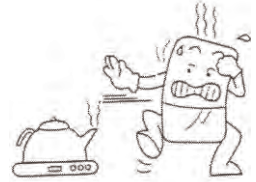

3. 使用時，請將本機遠離暖爐、電熱水壺等熱源，可節省用電。
- Do not operate unit near radiators, kettles or any object that releases steam.



4. 使用時，請關閉門窗，以達到最佳的抽濕效果。

Do not operate unit near windows or doors opening to the outdoor.

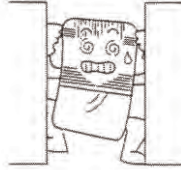

5. 請勿擺放物品在機體前後。通風若受阻，抽濕效果會受影響。

Do not obstruct air inlet and outlet.



6. 如遇停電或長期不使用時，請拔掉電源線插頭。

Unplug power when the unit is not in use for an extended period.



7. 清理機身時，以濕布輕輕擦拭即可，切勿直接射水。

Do not spray any liquid onto unit.



8. 請勿擺放任何物件在機身上。

Do not put heavy objects on top of unit.



9. 請每兩週清洗過濾網一次(切勿使用40°C以上熱水、酒精、汽油或甲苯)。
- Wash the air filter once every 2 weeks with cold water. (Do not use water >40°C, alcohol, petroleum or benzene)



10. 連續排水時，排水管須水平放置，不可高低不平及有纏繞情況。

When draining water continuously, make sure drain hose is not tangled.



11. 過濾網清潔後，請不要放置在太陽直射下曬乾，以避免變形。
- Do not place filter directly under the sun when drying.



12. 移動、搬運本機前，請先倒出水箱內積水。
- Empty water tank before moving unit.

技術規格 Technical Specifications

型號 Model	DHM-406
電壓 Voltage	220-240 V
頻率 Frequency	50 Hz
功率 Power	195 W
電流 Electric Current	1.0 A
抽濕能力 Dehumidifying Capacity	6.5 L / day
適用室溫 Applicable Room Temperature	5 °C - 32 °C
水箱容量 Capacity: Water Storage	1.8 L
尺寸 Dimensions	(H) 490 mm (W) 294 mm (D) 230 mm
包裝尺寸 Packing Dimensions	(H) 568 mm (W) 346 mm (D) 282 mm
淨重 Net Weight	12 kg
總重連包裝 Gross Weight With Packing	13 kg

產品規格及設計如有變更，恕不另行通知。
Specifications are subject to change without prior notice.

中英文版本如有出入，一概以中文版為準。
If there is any inconsistency or ambiguity between the English version and the Chinese version,
the Chinese version shall prevail.

如欲獲取更多有關本產品最新資訊，歡迎瀏覽本公司網站。
For additional product information, please visit our website.

www.germanpool.com

請填寫以下空格並與發票一併保存，以便維修時核對資料。用戶提供本公司之所有資料必須正確無誤，否則免費保用將會無效。
Please fill out the form below. This information and the purchase invoice will be required for any repairs. Warranty will be invalid if information provided is found to be inaccurate.

型號 Model No. : DHM-406

機身號碼 Serial No. : _____

發票號碼 Invoice No. : _____

購買商號 Purchased From : _____

購買日期 Purchase Date : _____

保用條款

此保用提供德國寶產品之機件在正常使用下壹年保用(自購買日起計算)。

* 貴戶須在購機十天內，以下列其中一種方式向本公司登記資料，保用手續方正式生效：

- 1) 填妥本公司網頁內之保用登記表格 www.germanpool.com/warranty。
- 2) 填妥保用登記卡，並連同購機發票之副本一併郵寄到客戶服務部 (本公司將不發還發票副本或登記卡)。

1. 未能出示購買發票正本者，將不獲免費維修服務。
2. 用戶應依照說明書的指示操作。本保用並不包括：
 - 上門安裝、檢驗、維修或更換零件之人工以及一切運輸費用；
 - 因天然與人為意外造成的損壞 (包括運輸及其他)；
 - 電源接合不當、不依說明書而錯誤或疏忽使用本機所引致之損壞。
3. 於下列情況下，用戶之保用資格將被取消：
 - 購買發票有任何非認可之刪改；
 - 產品被用作商業或工業用途；
 - 產品經非認可之技術人員改裝或加裝任何配件；
 - 機身編號被擅自塗改、破壞或刪除。
4. 總代理有權選擇維修或更換配件或其損壞部份。
5. 產品一經被轉讓，其保用即被視作無效。

維修部 - 小型電器

德國寶(香港)有限公司
香港九龍紅磡暢通道 1 號
中旅貨運物流中心8樓
電話：+852 2215 4582
傳真：+852 2356 9798
電郵：repairs@germanpool.com

Warranty Terms & Conditions

Under normal operations, the product will receive a 1-year full warranty provided by German Pool (effective starting from the date of purchase).

* This warranty is not valid until Customer's registration information is returned to and received by our Service Centre within 10 days of purchase via one of the following methods:

- 1) Visit our website and register online: www.germanpool.com/warranty.
- 2) Complete all fields on the attached Warranty Card and mail it back to our Customer Service Centre along with a photocopy of the purchase invoice (Warranty Card and invoice copy will not be returned to Customer).

1. Customer who fails to present original purchase invoice will be disqualified for free warranty.
2. Customer should always follow the operating instructions. This warranty does not apply to:
 - labour costs for on-site installation, check-up, repair, replacement of parts and other transportation costs;
 - damages caused by accidents of any kind (including transport and others);
 - operating failures resulted from incorrect voltage, improper operations and unauthorized installations or repairs.
3. This warranty is invalid if:
 - purchase invoice is modified by unauthorized party;
 - product is used for any commercial or industrial applications;
 - product is repaired or modified by unauthorized personnel, or unauthorized parts are installed;
 - serial number is modified, damaged or removed from the product.
4. German Pool will, in its discretion, repair or replace any defective part.
5. This warranty will be void if there is any transfer of ownership from the original purchaser.

Repair Centre - Small Appliances

German Pool (Hong Kong) Limited
8/F, China Travel (Cargo) Logistics Centre
1 Cheong Tung Road
Hung Hom, Kowloon, Hong Kong
Tel : +852 2215 4582
Fax : +852 2356 9798
Email : repairs@germanpool.com

此保用只適用於香港

This warranty is valid only in Hong Kong

GERMAN
POOL



德國寶

德國寶 (香港) 有限公司 German Pool (Hong Kong) Limited

香港總代理 Hong Kong Sole Agent

九龍土瓜灣馬頭角道116號新寶工商中心高層地下2-4號室
Room 2-4, Upper G/F, Newport Centre, 116 Ma Tau Kok Road,
Tokwawan, Kowloon

電話 Tel: +852 2333 6245 傳真 Fax: +852 2765 8215

中國總代理 China Sole Agent

廣東省佛山市順德區南國東路永旺(吉之島)購物中心3樓
3/F, Yongwang (Jusco) Shopping Mall, Nanguo East Road,
Shunde, Foshan, Guangdong

電話 Tel: +86 757 2980 8308 傳真 Fax: +86 757 2980 8318



© 版權所有。未獲德國寶授權，不得翻印、複製或使用本說明書作任何商業用途，違者必究。

© All rights reserved. Copying, reproducing or using the contents of this manual is not allowed without prior authorization from German Pool, violators will be prosecuted.

www.germanpool.com