

GERMAN
POOL



德國寶

分體式掛牆冷氣機
AIR CONDITIONER
WALL-MOUNT SPLIT SERIES

ST-24

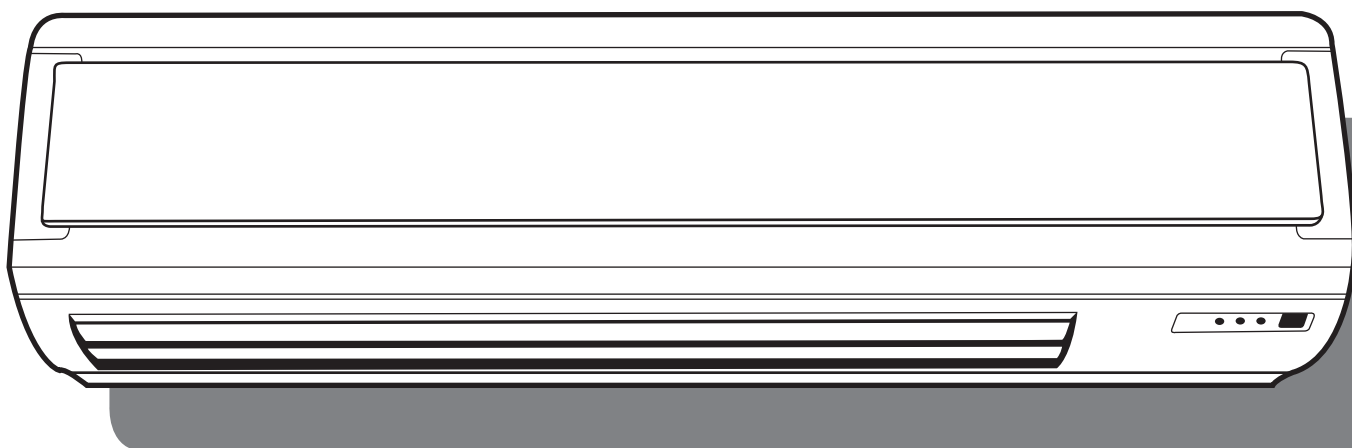

在使用之前請詳細閱讀「使用說明書」及「保用條例」，並妥為保存。
Please read these instructions and warranty information
carefully before use and keep them handy for future reference.



使用說明書 OPERATING INSTRUCTIONS

CONTENTS

Please read this
OWNERS MANUAL
carefully prior to
use.....



Structure and mechanism	Functions	1
	Operation mechanism	2
	Important notices	3
	Structure description	4
Remote control operation procedure	Name and Function-Remote control	5
	Name and Function-Remote control(Remove the cover)	6
	COOL mode operation procedure	7
	HEAT mode operation procedure	8
	DRY mode operation procedure	9
	SLEEP mode operation procedure	10
	AUTO mode operation procedure	11
	TIMER mode operation procedure	12
	How to insert batteries	13
Care and maintenance	Emergency run operation procedure	14
	Air flow direction adjustment procedure	14
	Special performance	15
	Operation conditions	15
	Installation precaution	16
	Care and maintenance	17
	When malfunction happening	18
	Installation dimension diagram	19
	Installation location	20
	Install the indoor unit	21
	Install the outdoor unit	23
Routine check after installation	25	

For to prevent flicker impressions during the start of the compressor (technical process)following installation conditions do apply.

- 1 GWHN24C1NK3AA, GWCN24C1NK3AA, GWHN24C1NK3AB, GWHN24C1NK3AC will be connected only to a supply with the relevant system impedance no more than $Z_{max}=0.228 \Omega$.
- 2 The power connection for the air conditioner has to be done at the main power distribution. This distribution has to be of an low impedance. Normally the required impedance is eached at a 32A fusing point.
- 3 No other equipment has to be connected to this power line.
- 4 For detailed installation acceptance please refer to your contract with the power supplier, if restrictions do apply far products like washing machines air conditioners or electrical ovens.
- 5 For power details of the air conditioner refer to the rating plate of the product.
- 6 For any question contact your local seller.
- 7 This product must not be disposed together with the domestic waste.
This product has to be disposed at an authorized place for recycling of electrical and electronic appliances.

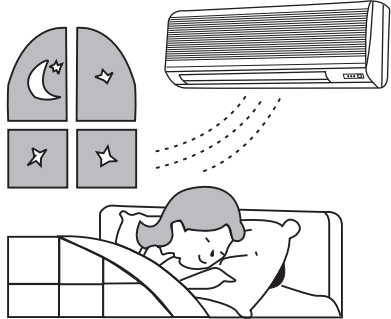

Functions

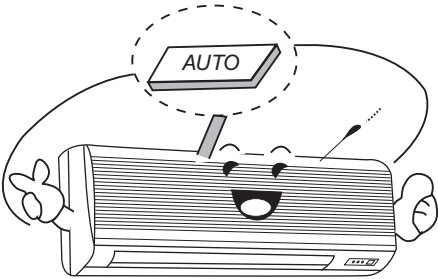
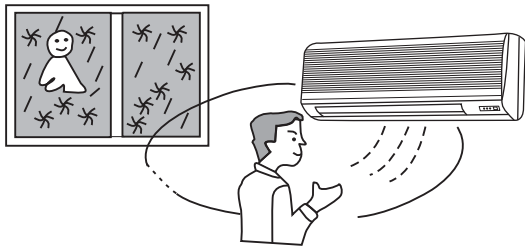
Cooling in summer	Dehumidifying in rainy or humid season
<p>In hot summer, air conditioner can cool room air by transferring heat out.</p> 	<p>Without reducing room temp., air conditioner can dehumidify and make room air dry and comfortable.</p> 
Operating automatically	Heating in winter (heat pump type)
<p>According to room temp. change, microcomputer can automatically set COOL or HEAT or FAN operation mode, so as for best effect.</p> 	<p>In cold winter, air conditioner can supply warm air to rise room temp.</p> 

※ Working temperature range

	Indoor side DB/WB(°C)	Outdoor side DB/WB(°C)
Maximum cooling	32/23	43/26
Minimum cooling	21/15	—
Maximum heating	27/ —	24/18
Minimum heating	20/ —	— 5/ — 6

※ Working voltage: 50Hz 220-240V~

※ Installation precaution:

- ① To prevent possible hazards due to insulation failure, the unit must be grounded.
- ② Provide a power outlet to be used exclusively for each unit, and a power supply disconnect and circuit breaker and current fuse protector should be provided in the exclusive line.
- ③ Each wiring connection must be done in accordance with the wiring system diagram. Wrong wiring may cause the unit to misoperate or become damaged.
- ④ Please cut off power supply when unit will not be used for a long time.
- ⑤ An all-pole disconnection switch having a contact separation of at least 3mm in all poles should be connected in fixed wiring.

Operation mechanism

Cooling cycle

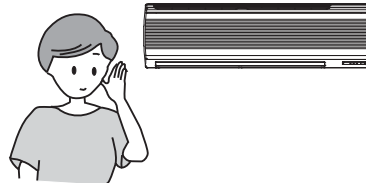

Connected with pipes, indoor unit and outdoor unit form a refrigeration system. With power, compressor takes in low temp. and low pressure refrigerant vapour from evaporator of indoor unit, presses it into high temp. and high pressure gas, then discharges it into condenser of outdoor unit. By help of axial flow fan, heat is removed to outdoor air from the gas which then condenses into liquid. After capillary tube throttling, the liquid drops temp. and pressure, flows into evaporator. There, by help of cross-flow fan, the liquid absorbs heat from room air, evaporates and becomes low pressure vapour which then flows into compressor again, beginning next cooling cycle. Therefore, heat is transferred from indoor to outdoor, and room gets cool.

Ventilation cycle



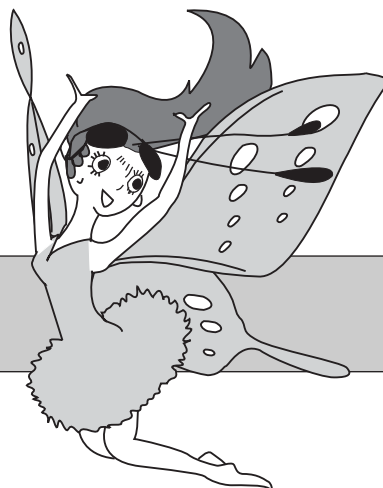

Ventilation cycle divides into indoor and outdoor two parts. With suction of cross-flow fan, room air flows through filters, exchanges heat in evaporator, then returns to room. In this way, room air can be cool and dehumidified. At the same time, pumped by axial-flow fan, outdoor air flows through condenser and exchanges heat.



Heating cycle

Heat pump type air conditioner uses a commutator (4-way electromagnetic valve) to change refrigerant flow direction. When heating, refrigerant firstly enters indoor heat-exchanger, releasing heat and condensing. Then it enters outdoor heat-exchanger, absorbing heat and evaporating. Because consumption power changes into heat which is discharged in room, heating efficiency is very good.

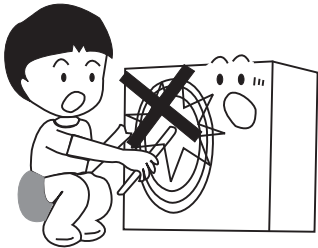
Important notices

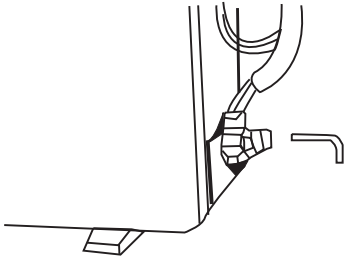
<p>Air Conditioner should be operated with stable voltage in range of 198-253V~1Ph, otherwise, compressor would vibrate terribly to damage refrigeration system.</p> <p>50Hz 220-240V ~</p> 	<p>Do not cut or pull strongly power lines and connecting lines.</p> 	
<p>Do not insert any foreign materials into the air inlet or air outlet, it is very dangerous.</p> 	<p>Close doors and windows (better using curtains) while operating air conditioner, to avoid cool or heat leakage which affects air condition. If room air is quite turbid, you should open a door or window a little for a moment to get some outdoor fresh air.</p> 	
<p>It is only specific technician who can operate the stop valve of outdoor unit, otherwise it is possible to make refrigerant leak out and compressor breakdown.</p> 		
<p>Delay operation</p> <p>To avoid action of overload protector or other security devices, we design a delay for 3~4 minutes before starting cooling or heating or dehumidifying cycle in following situations:</p> <ul style="list-style-type: none"> • To start again immediately after stopping; • To adjust operation mode. 	<p>Smell</p> <p>Sometimes there is some smell out of indoor unit, as does not mean any machine failure, but because of suction air mixed with smell of furniture or smoking etc.</p>	<p>Electric circuit</p> <p>Must use special electric circuit, do not use longer power lines, do not share a same socket with other electric appliances to avoid fire etc.</p>

Structure description

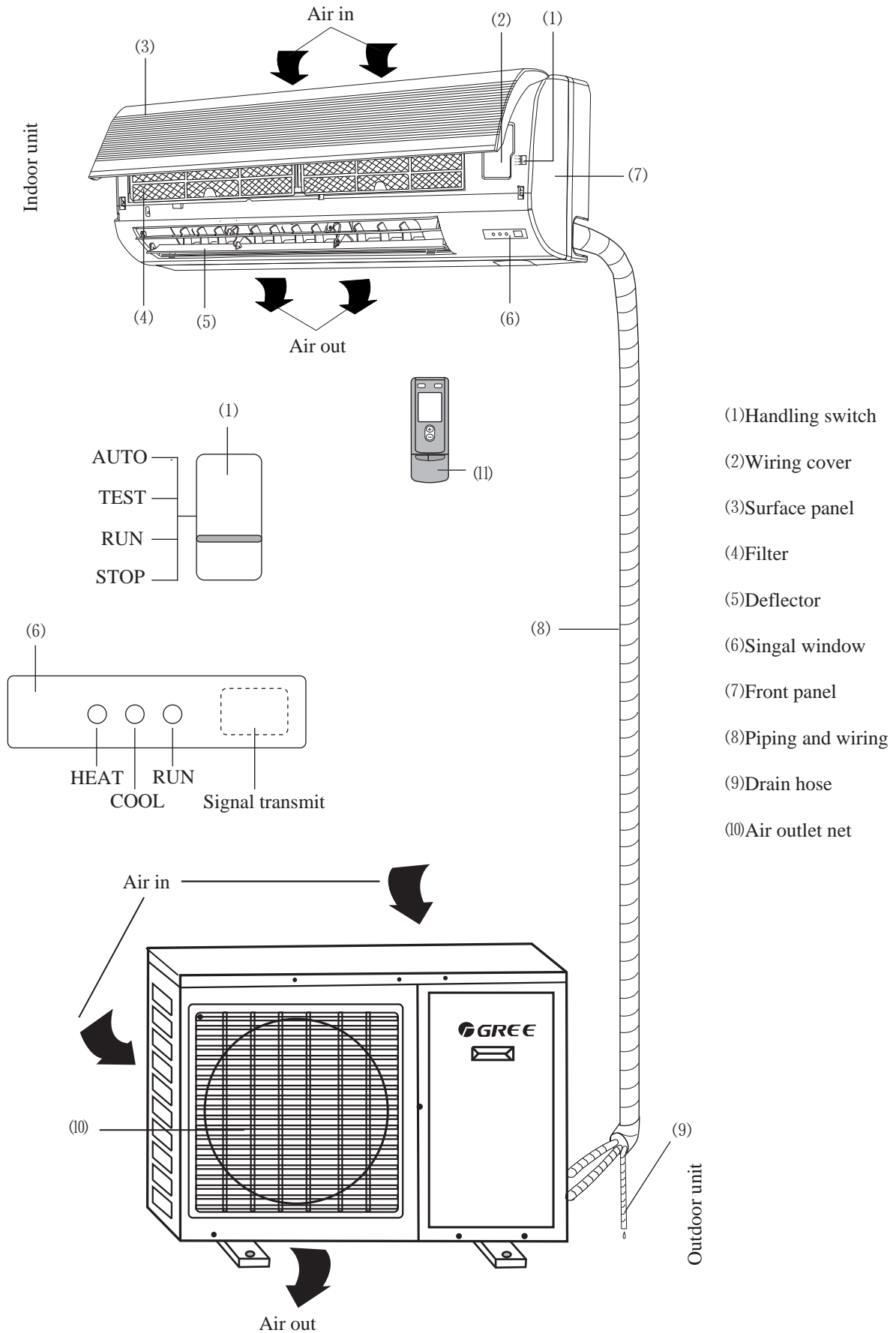

Remote control operation procedure

● Name and Function-Remote control

Note:

- Be sure that there are no obstructions.
- The remote control signal can be received at a distance of up to about 10m.
- Don't drop or throw the remote control.
- Don't place the remote control in a location exposed to direct sunlight.

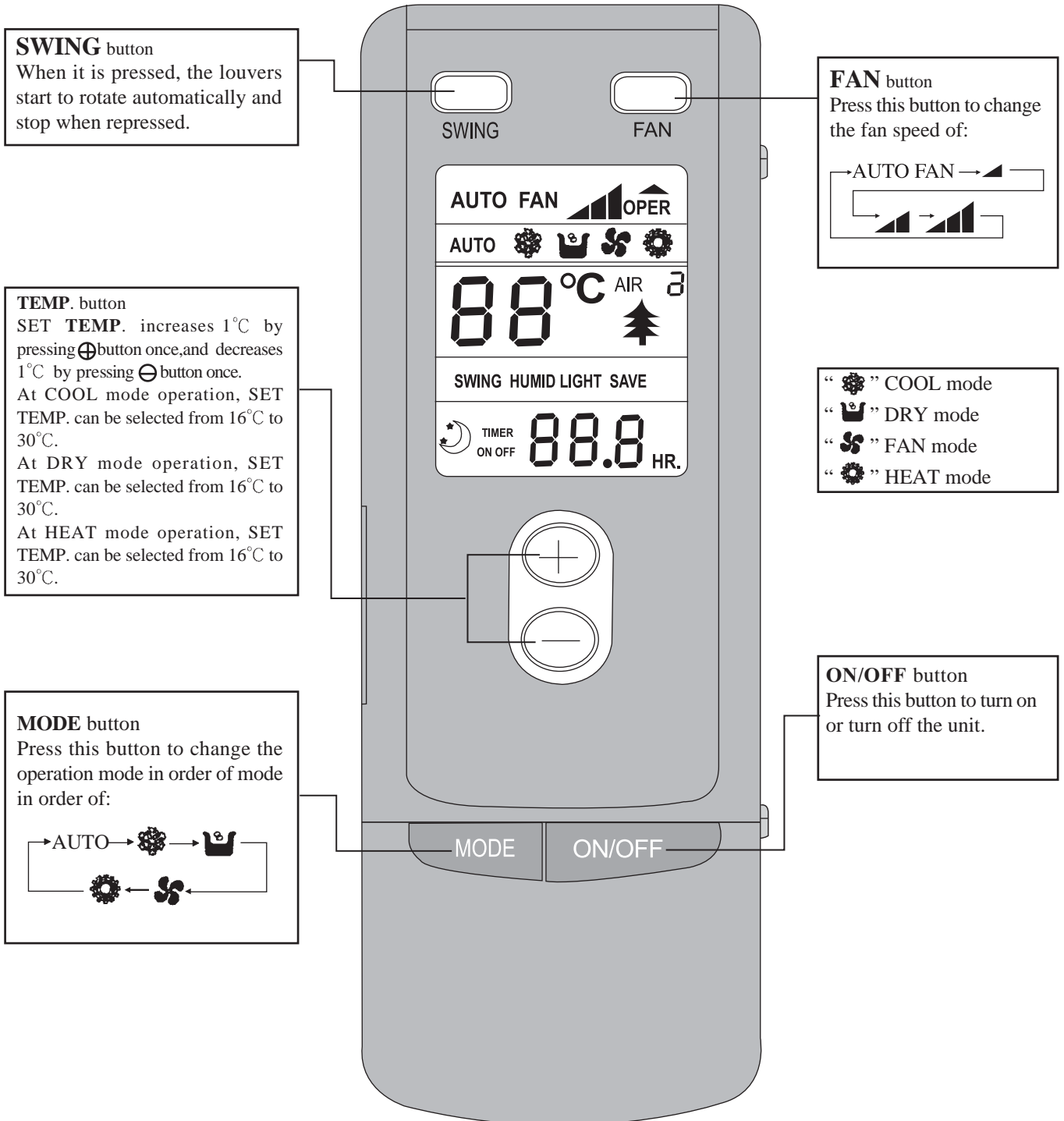

● Name and Function-Remote control. (Remove the cover)

Note:This type of remote controller is a kind of new current controller.

some buttons of the controller which are not available to this Air conditioner will not be described below.

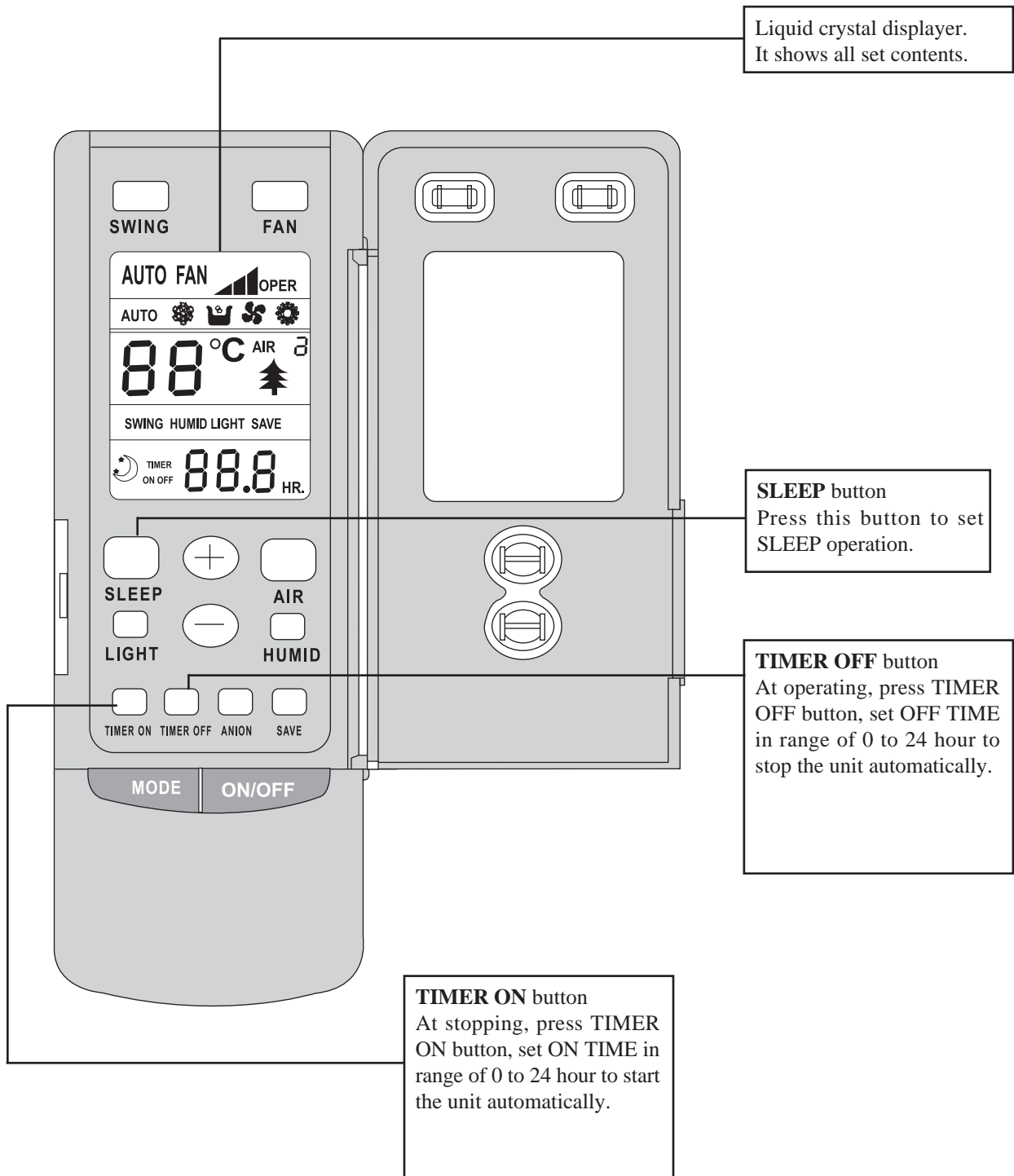

● COOL mode operation procedure

- According to difference between room temp. and set temp., microcomputer can control cooling on or not.
- If room temp. is higher than set temp., compressor runs at COOL mode.
- If room temp. is lower than set temp., compressor stops and only indoor fan motor runs.
- SET TEMP. should be in range of 16°C to 30°C .

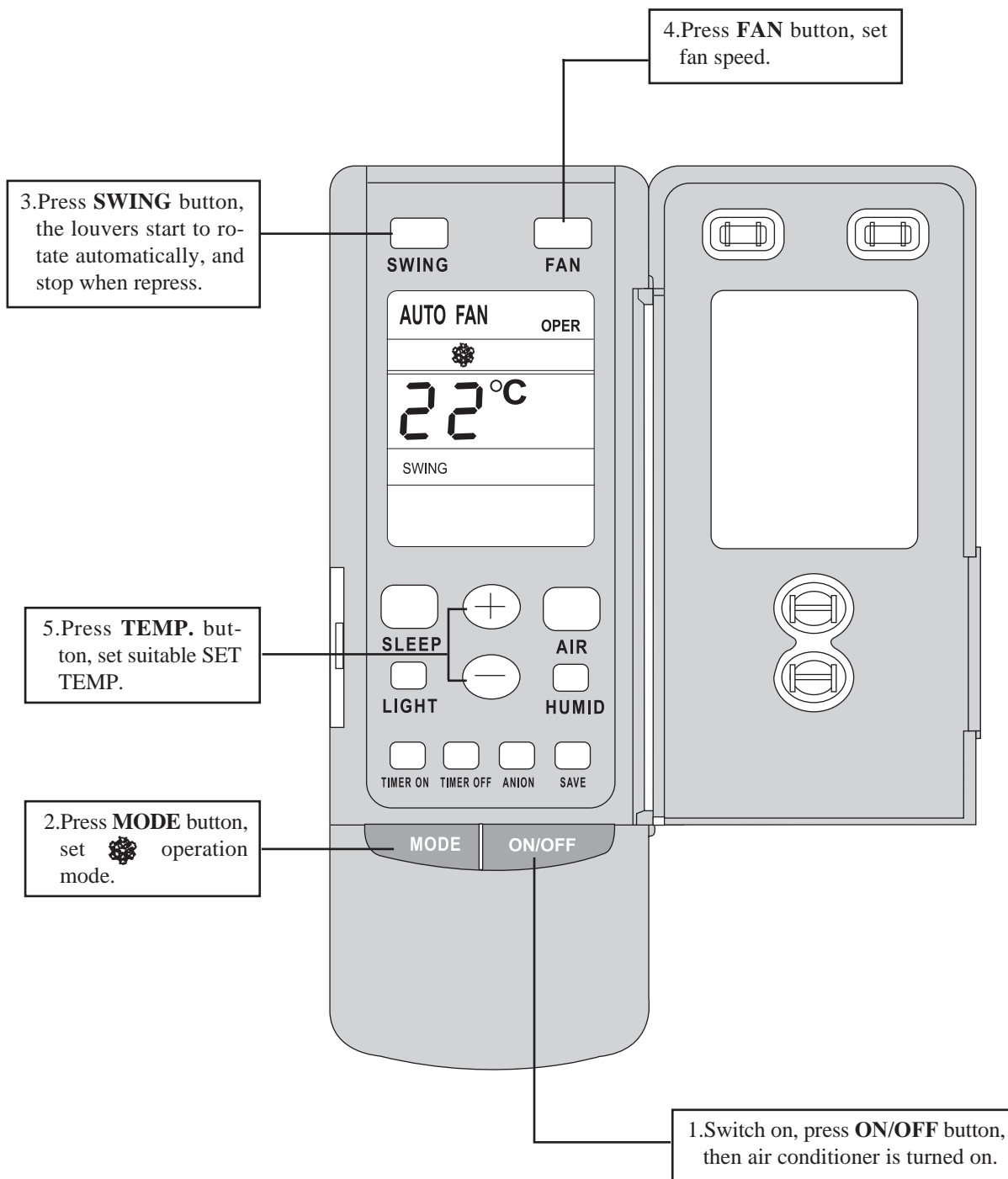

● HEAT mode operation procedure

- If room temp. is lower than set temp., compressor runs at HEAT mode;
- If room temp. is higher than set temp., compressor and outdoor fan motor stop, only indoor fan motor runs.
- SET TEMP. should be in range of 16°C to 30°C .

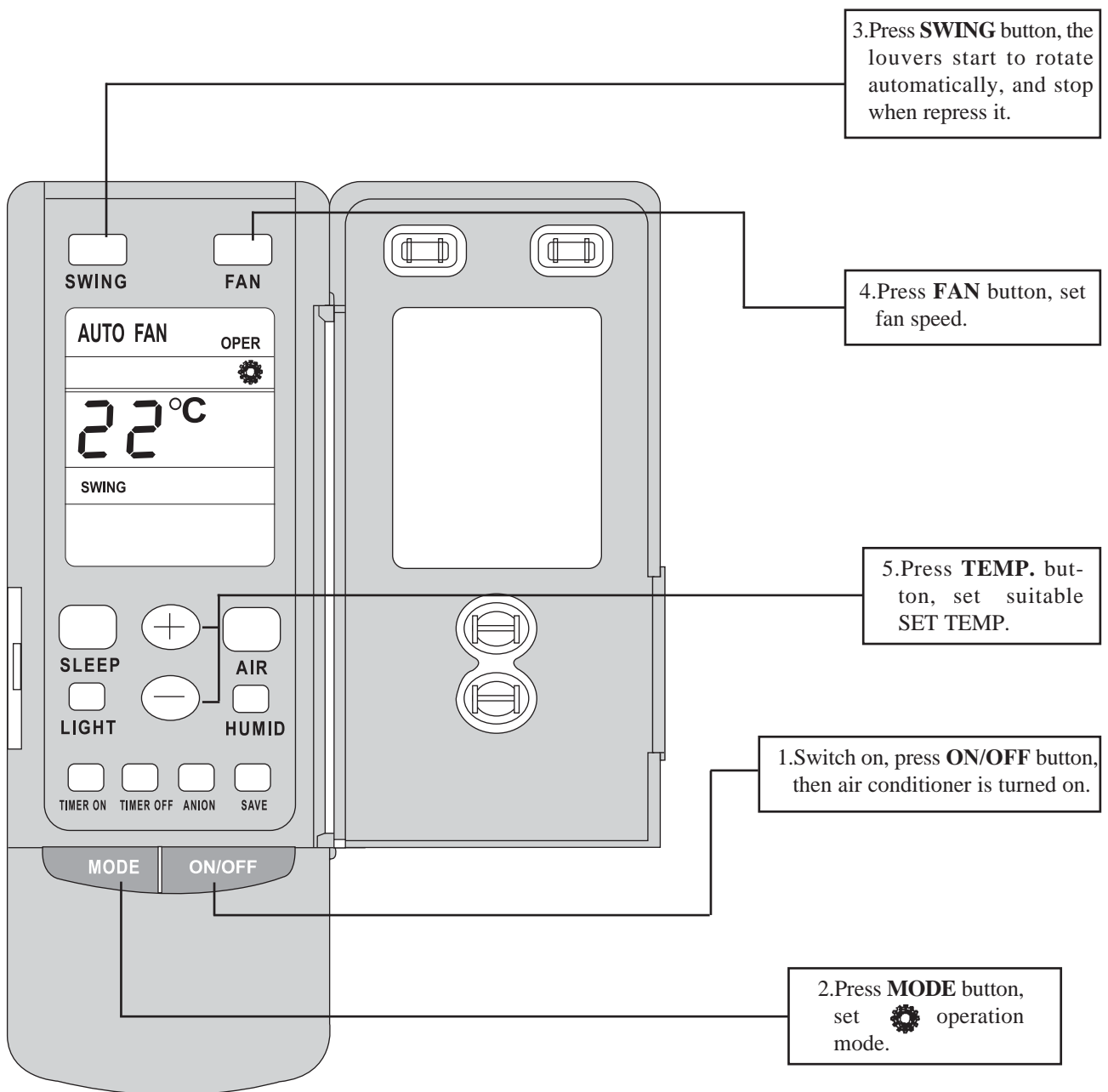

● DRY mode operation procedure

- If room temp. is lower than set temp., compressor , outdoor and indoor fan motor stop. If room temp. is between $\pm 2^{\circ}\text{C}$ of set temp., Air conditioner is drying. If room temp. is higher than set temp., it's at COOL mode.
- SET TEMP. should be in range of 16°C to 30°C .

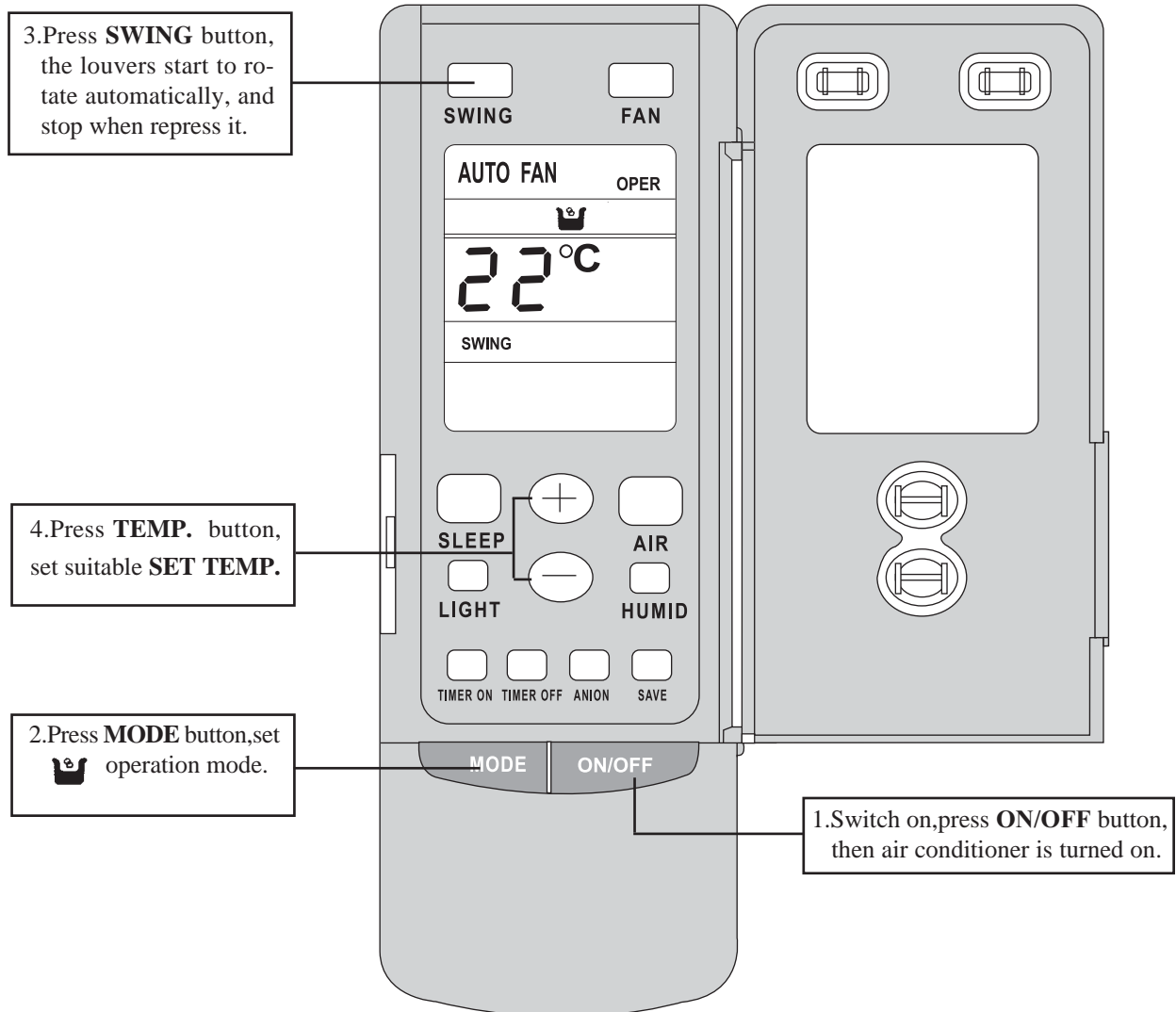

● SLEEP mode operation procedure

- When the unit is cooling or drying, if SLEEP operation is set, SET TEMP. would increase 1°C in 1 hour and 2°C in 2 hours. Indoor fan motor runs at low speed.
- When the unit is heating, if SLEEP operation is set, SET TEMP. would decrease 1°C in 1 hour and 2°C in 2 hours. Indoor fan motor runs at low speed.

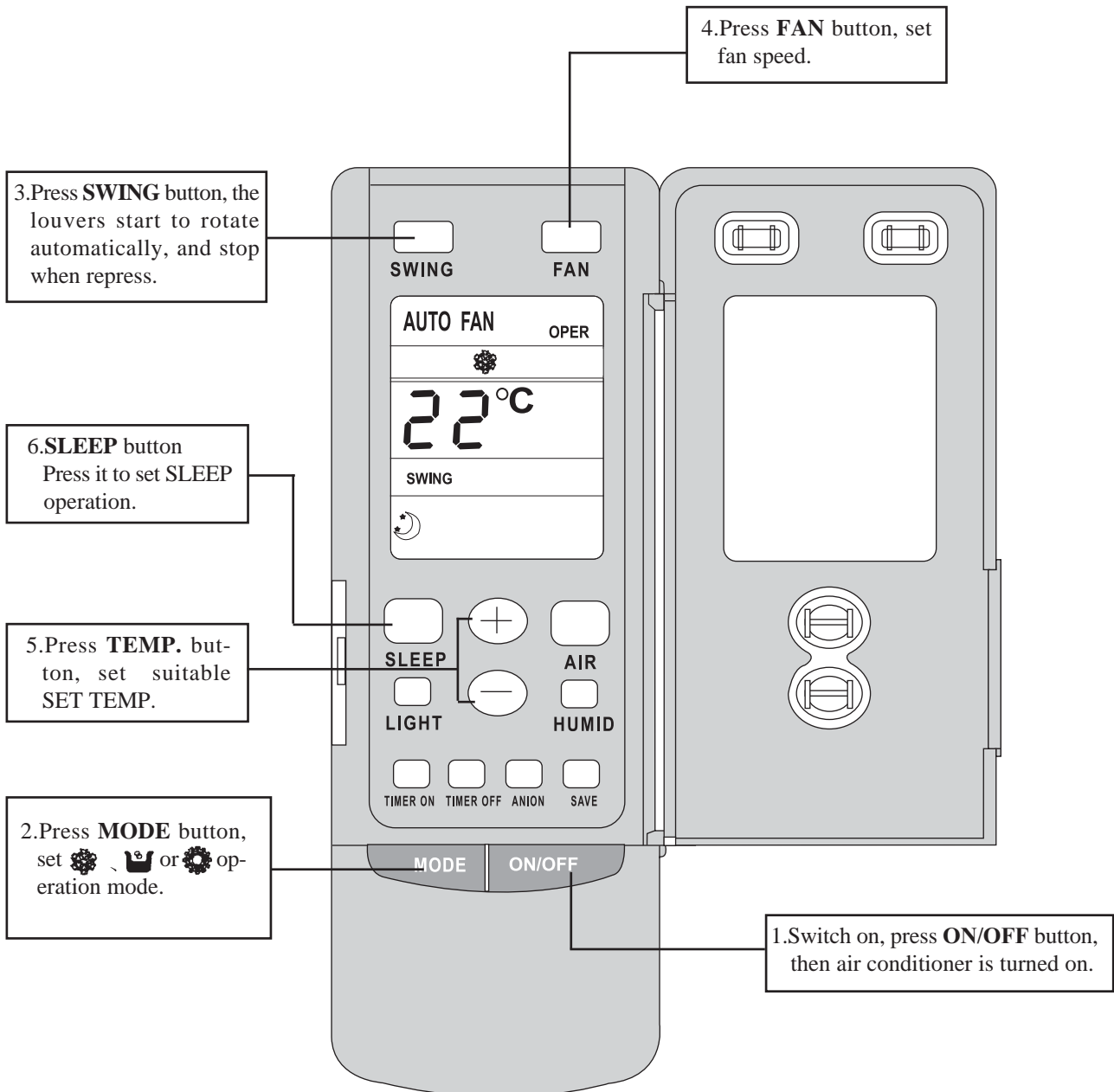

● AUTO mode operation procedure

- At AUTO mode operation, standard SET TEMP. is 25°C for COOL mode and 20°C for HEAT mode.

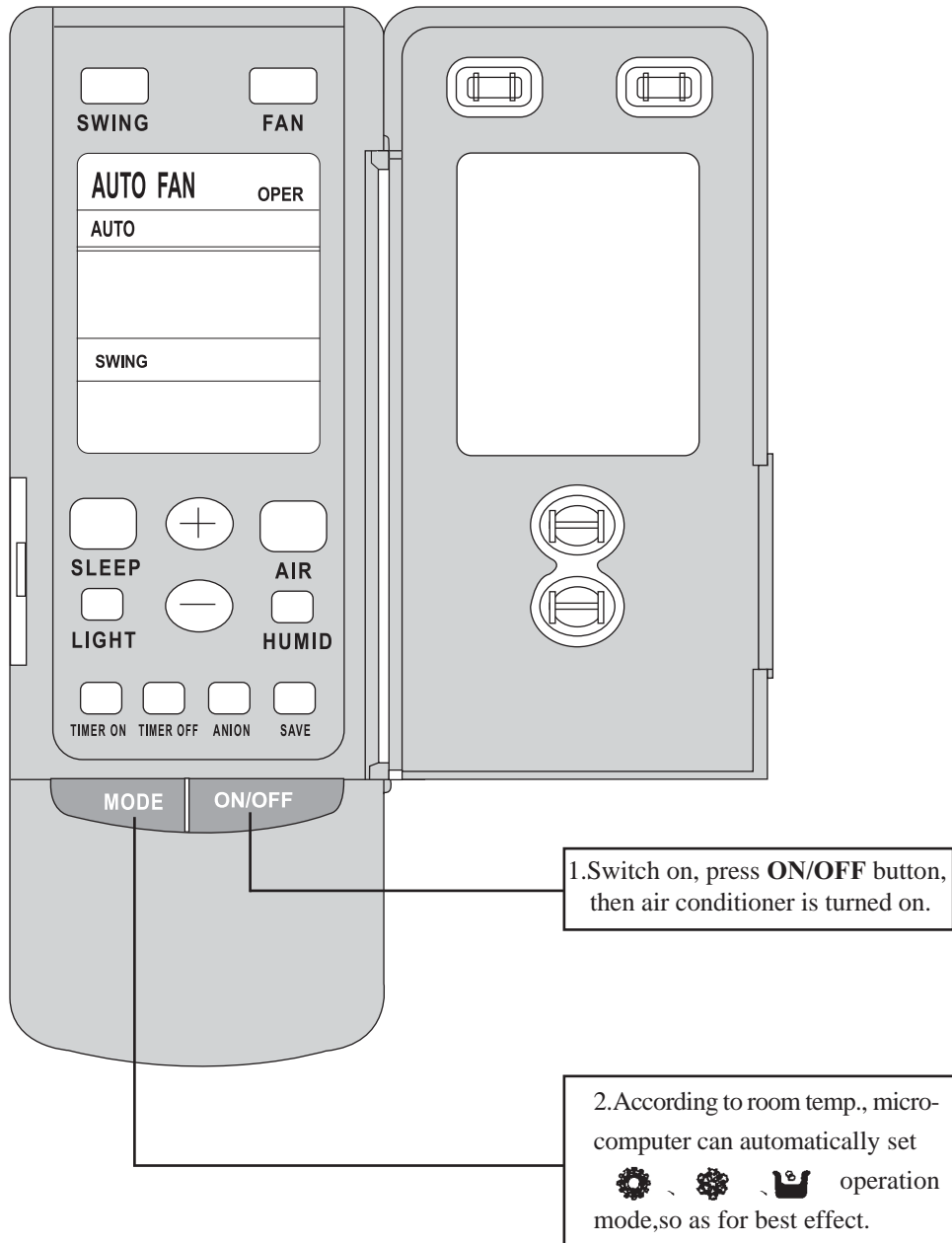

● TIMER mode operation procedure

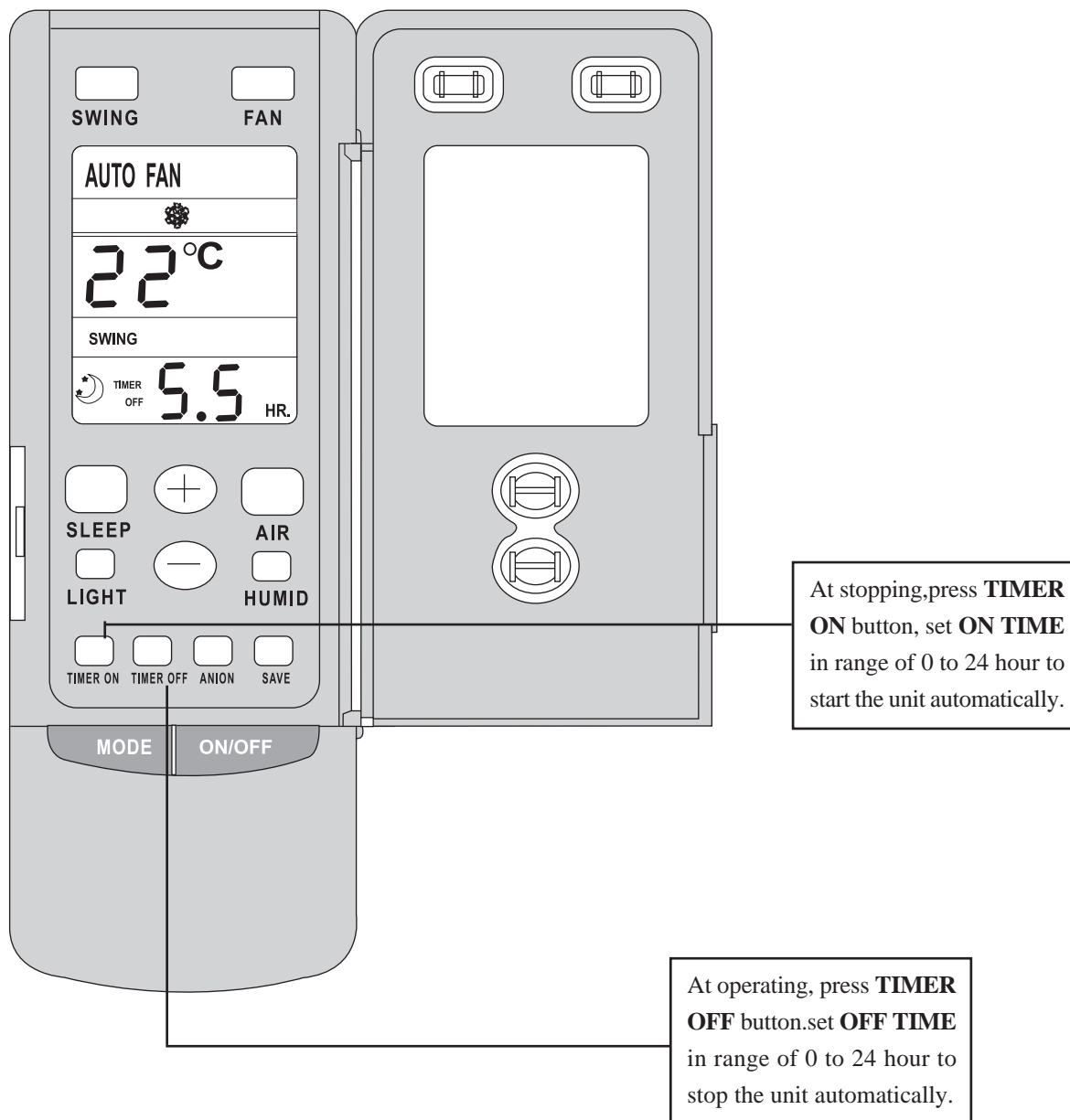

● How to insert batteries

1. Remove the cover from the back of the remote control.
2. Insert the two batteries (Two AAA dry - cell batteries) and press button “ACL”.
3. Re - attach the cover.

NOTE:

- Don't confuse the new and worn or different batteries.
- Remove batteries when not in use for a long time.
- The remote control signal can be received at a distance of up to about 10m.

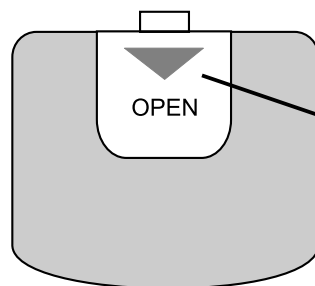
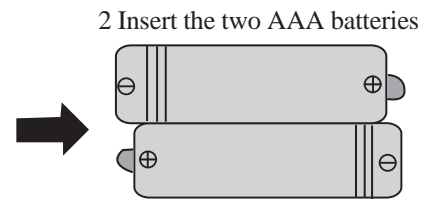
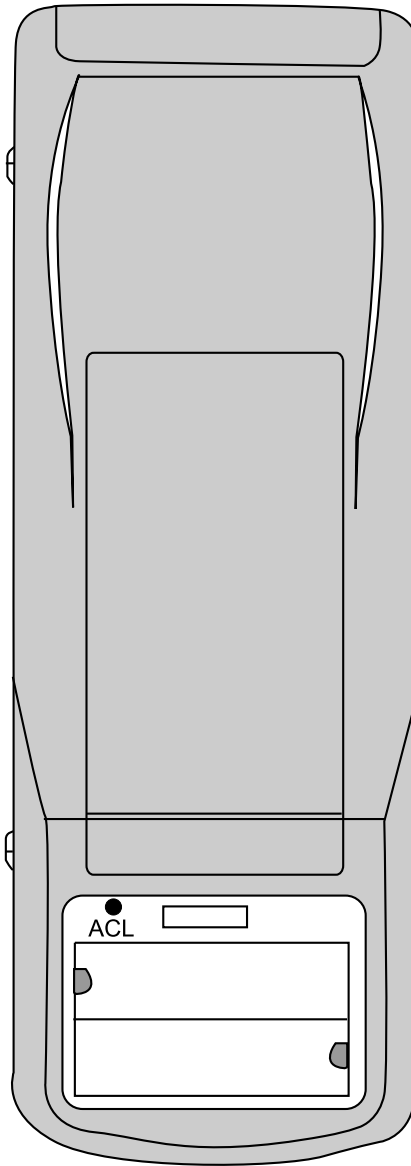

- 1 Remove the cover
- 3 Re - attach the cover.

Emergency run operation procedure

If Wireless remote controller lost, open the surface panel and operate as following:

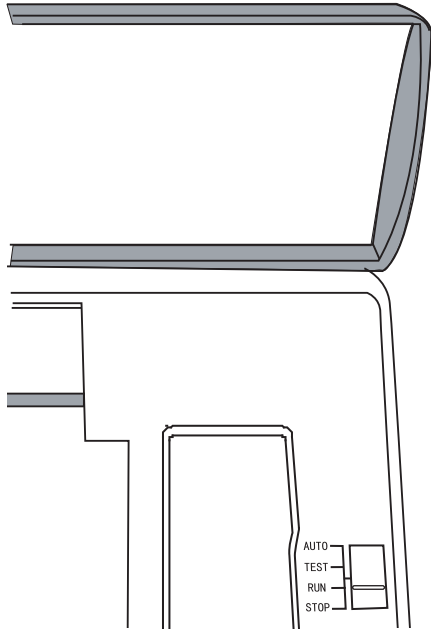

Manual switch (Auto, Test, Run, Stop)

- When turning it to Auto position, unit will run in Auto mode, if there is remote control signal, it will run at the remote control signal.
- When turning it to Test position, the main unit will enter into Cool mode, indoor fan will run at high fan speed, if there is remote control signal, main unit will run at the remote control signal, at this time to shield the low pressure switch.
- When turning it to Run position, the main unit will run at the received remote control order.
- When turning it to Stop position, the unit will stop running.

Air flow direction adjustment procedure

1. Adjusting up/down air flow direction

With wireless remote controller, adjust air flow direction by rotating the UP/DOWN deflectors up and down automatically or stopping at an angle.

* Press SWING button, the deflectors start to rotate and stop when repress.

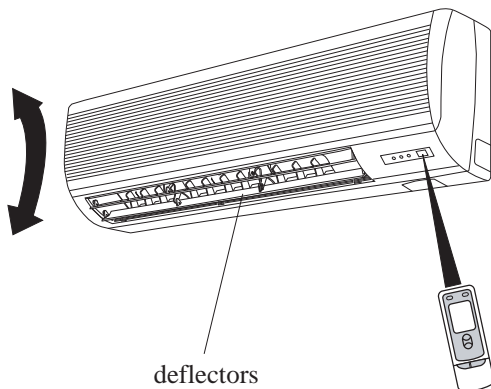

2. Adjusting left/right air flow direction

As shown, move the LEFT/RIGHT deflectors by hand, adjust air flow left or right or three different directions to every corner of room so as to make everywhere temp. average.

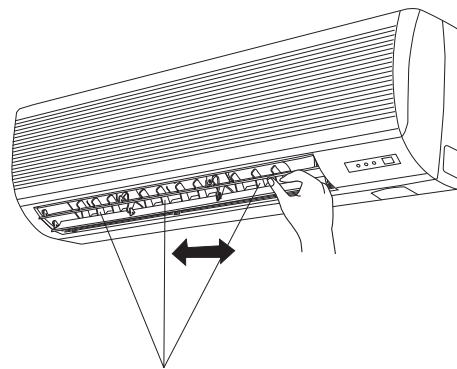

Special performance

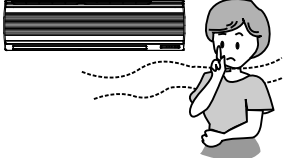
Time delay in heating	When power is failed
<p>* To avoid cold air,indoor fan motor does not start till compressor works for 30 seconds.</p> <p>* To keep heating,when room temp. reaches SET TEMP. and compressor stops,indoor fan motor works at LOW speed.</p> 	<p>* All operations stop.</p> <p>* Press ON/OFF button to restore operations.</p> <p>* If made mistakes in operation,Switch off,then plug in well,and press ON/OFF button.</p>

Operation conditions

<p>COOL mode operation</p> <p>Outdoor temp. should be in range of 18°C to 43°C, otherwise it is possible for air conditioner to breakdown.</p> <p>Room temp. should be in range of 16°C to 32°C.</p> <p>Room humidity should be lower than 80%, otherwise it is possible to dew at air conditioner surface and even drop water.</p>	<p>Avoiding evaporator frost</p> <p>After compressor continually working more than 6 minutes,and evaporator pipe temp. keeping no higher than 0 °C in 3 minutes,the compressor and outdoor fan motor stop,while indoor fan motor runs at SET SPEED. When evaporator pipe temp. is not lower than 10°C,and after 3 minutes delay,air conditioner restores previous operation.</p>
<p>DRY mode operation</p> <p>Outdoor temp. should be in range of 18 °C to 43 °C,otherwise it is possible for air conditioner to breakdown.</p> <p>Room temp. should be in range of 16 °C to 32 °C.</p>	<p>HEAT mode operation</p> <p>Outdoor temp. should be over -5°C,otherwise it is possible for protect devices inside to act and air conditioner can not start.</p>

Installation precaution

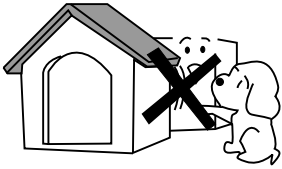
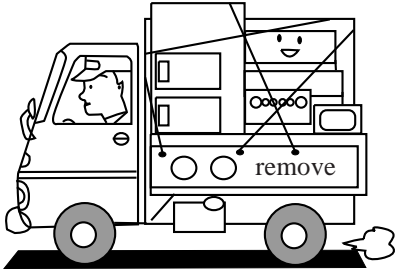
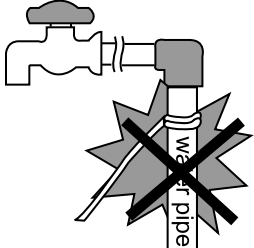
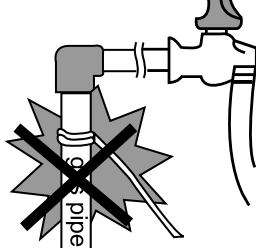
Installation position	Noise
<ul style="list-style-type: none"> * Drain the condensed water from indoor unit into ground pipe. * Install indoor unit far away TV set or radio etc., to avoid disturbing video or voice. * In salt and coastal area or place where is near thermal springs and polluted by sulphureous gas, or other special areas, please contact with seller before use. * Avoid place where is possible for flammable gas to leak out. * Avoid other heat sources or direct sun light. * Avoid place where is easy for children to touch. 	<ul style="list-style-type: none"> * Install on place firmly enough to avoid transmitting or increasing noise and vibration. * Do not put objects in front of outdoor unit air outlet, to avoid increasing noise. * Be sure not to make trouble to neighbors with hot air or noise from outdoor unit. * Please contact with saler as soon as there is strange noise during operation. <div style="text-align: center;">  </div>
Remove	Electric lines location
<p>When remove air conditioner to other place, it needs special technician, so contact with seller firstly.</p> <div style="text-align: center;">  </div>	<ul style="list-style-type: none"> * Must connect with ground. * Must use rated voltage and electric circuit specific for air conditioner. * Do not pull power lines strongly. * To fit an electrical leakage-proof switch, please contact with special electric seller. * Chose proper fuse to meet with the current specification. * Power lines should be thick enough.
Earth wire Do not connect earth wire to following places:	
<p>Water pipe Sometimes, there is some plastic material such as polythene used as part of water pipe, which is not available for earth.</p> <div style="text-align: center;">  </div>	<p>Gas pipe If there is electrical leakage accidentally from air conditioner, it is easy to cause fire or explosion, as is very dangerous.</p> <div style="text-align: center;">  </div>

Care and maintenance

Cleaning unit

1. Switch off first before cleaning.

Switch off only after air conditioner stops at all.

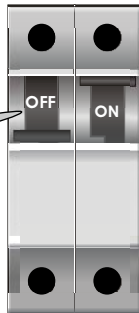

2. Clean surface panel with a soft and dry cloth, which is soaked warm water below 40°C



Must dry the cloth by hands before cleaning

3. Do not use chemical solvent for cleaning.

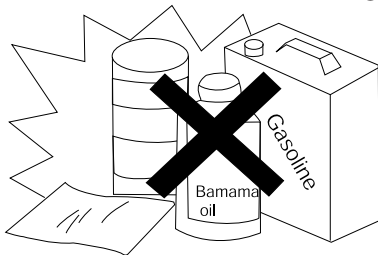

4. Do not splash water directly to indoor unit, in which there are microcomputer and circuit plate, they must not be touched by water.

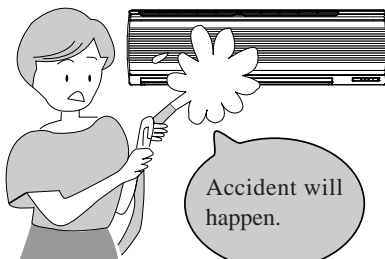

* Check earth wire

Is it broken or loose?

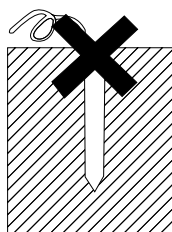

Cleaning filters

Air filters should be cleaned once every two weeks.

1. Open surface panel only after air conditioner stops at all.

- ① Pull here up (both sides of the surface panel);
- ② Push filters up till hooks are free from the front panel;
- ③ Pull down and take out filters.

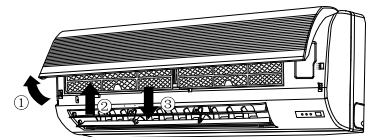

2. Clean filters with a vacuum cleaner or by typing them gently.

If they are very dirty, wash them in warm water below 40°C dissolved with neutral scouring agent, then dry them in cool air.

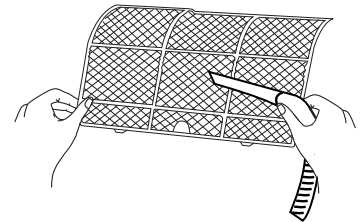

3. Insert them at original position, then push down and close surface panel.

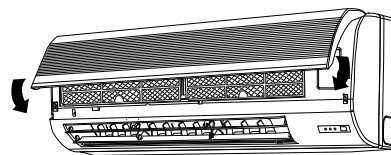

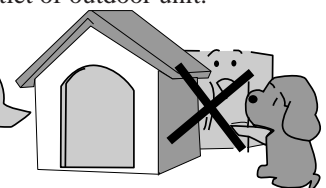

* Check air inlet and outlet of outdoor unit.

Air lock could result in bad efficiency.

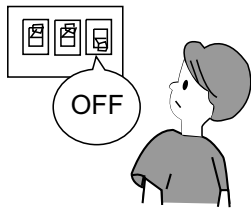

When malfunction happening

Please check the following items before ask for repair,it saves your time and money.

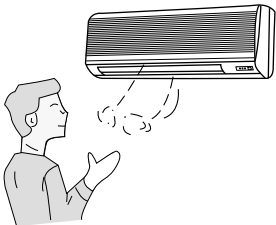
Fault phenomenon	Trouble shooting
<p>Air conditioner does not operate at all.</p> 	<ul style="list-style-type: none"> * Is power fail? * Is switch off? * Is power fuse or switch off? * Is voltage higher than 264V or lower than 206V? * Is SET TIME suitable?
<p>Cooling efficiency is not good.</p> 	<ul style="list-style-type: none"> * Is air inlet or outlet locking? * Is there any other heat source in room? * Are air filters dirty very much? * Is indoor fan speed set at LOW? * Is SET TEMP. suitable?
<p>Wireless remote controller is not available.</p> 	<ul style="list-style-type: none"> * If disturbed abnormally or operation modes changed too frequently,sometimes the electric controller would lose function.Please plug out and plug in again, it maybe OK. * Check batteries of wireless remote controller,if voltage is little,change batteries. * If wireless remote controller displays unclear or displays all symbols,please change batteries.
<p>Foggy air flows out.</p> 	<ul style="list-style-type: none"> * At COOL or DRY mode operation,sometimes there is foggy air flowing out of indoor unit,this is because that room humid air has been cooling rapid.

Immediately stop all operations and plug out,contact with your seller in the following situations.

- * Operation starts or stops abnormally;
- * Power fuse or switch often breaks;
- * Carelessly splash water or something into air conditioner;
- * Electrical lines are much hot or lines cover breaks;
- * Other strange situations.

● Installation dimension diagram

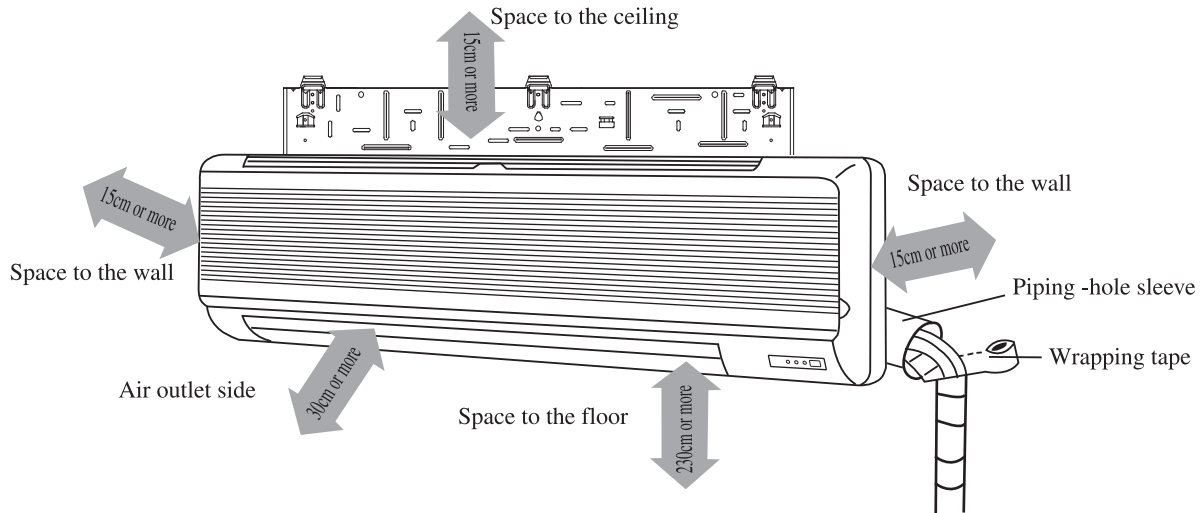

IMPORTANT NOTES

- * The installation must be done by trained and qualified service personnel with reliability according to this manual.
- * Contact with service center of GREE before installation to avoid the malfunction due to unprofessional installation.
- * When picking up and moving the units, you must be guided by trained and qualified personnel.
- * The distance between air outlet and the combustible must be over 50cm if the heater element is equipped.

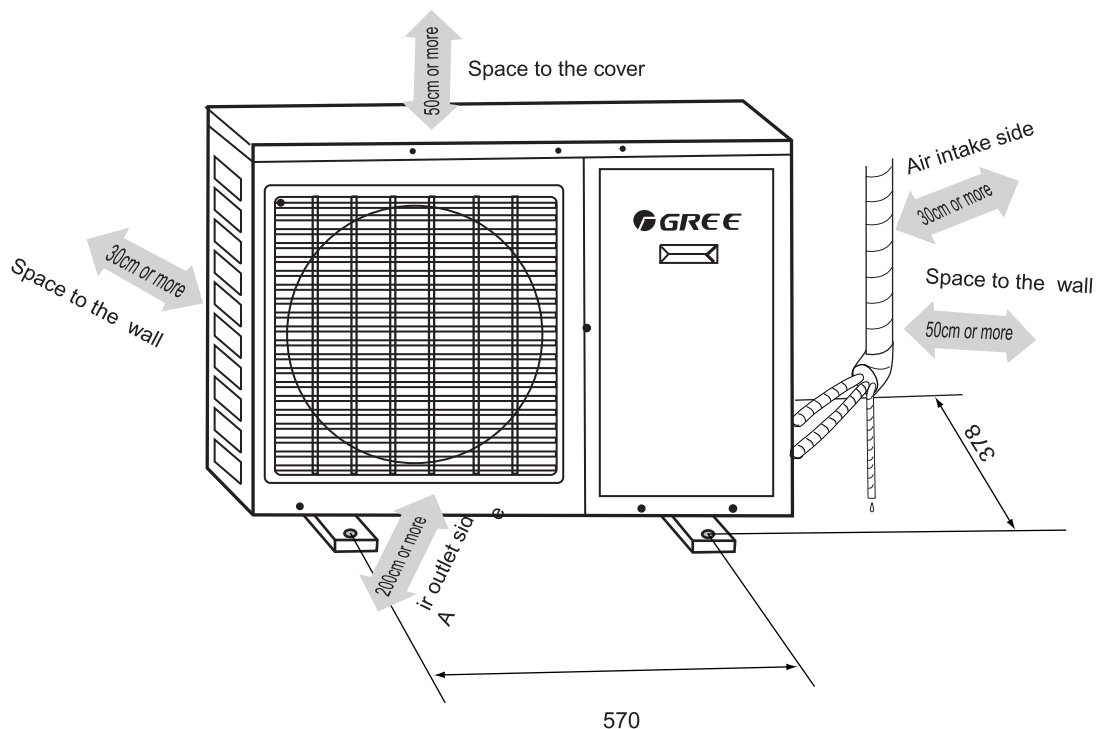

10. Do not use the unit in the immediate surroundings of a laundry, a bath, a shower, or a swimming pool.

Installation location

● Indoor unit

1. The inlet and outlet should not be covered so that the outflow air can reach all parts of the room.
2. Install in a location where it is permitting easy connection with the outdoor unit.
3. A location from which the condensation water can be drained out conveniently.
4. Avoid a location where there is a heat source, high humidity, or inflammable gas.
5. Install in a location where it is strong enough to withstand the full weight and vibration of the unit.
6. Be sure that the installation conforms to the installation dimension diagram.
7. Be sure to leave enough space to allow access for routine maintenance.
8. Install in a location where it is 1m or more away from other electric appliances such as television, audio device, etc.
9. Select a location where it is easy to remove and clean the filter.

● Outdoor unit

1. Select a location from which noise and outflow air emitted by the unit will not inconvenience neighbors.
2. Select a location where there should be sufficient ventilation.
3. The inlet and outlet should not be covered.
4. The location should be able to withstand the full weight and vibration of the outdoor unit.
5. There should be no danger of flammable gas or corrosive gas leaks.
6. Be sure that the installation conforms to the installation dimension diagram.

Install the indoor unit

● Install the rear panel

1. Always mount the rear panel horizontally.
2. Fix the rear panel on the selected location with screws supplied with the unit.
3. Be sure that the rear panel has been fixed firmly enough to withstand the weight of an adult of 60kg, furthermore, the weight should be evenly shared by each screw.

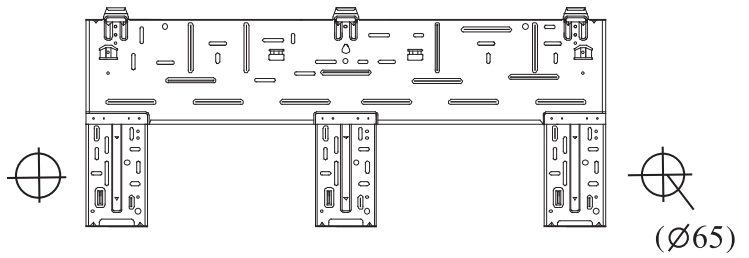

(Fig.2)

● Install the drain hose

1. For well draining, the drain hose should be placed at a downward slant.
2. Do not wrench or bend the drain hose or flood its end by water.

● Install the piping hole

1. Make the piping hole ($\phi 65$) in the wall at a slight downward slant to the outdoor side. The center of the hole should be determined refer to Fig.2.
2. Insert the piping-hole sleeve into the hole to prevent the connection piping and wiring from being damaged when passing through the hole.

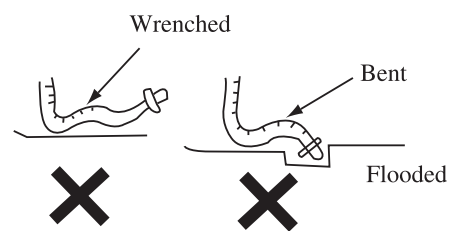

(Fig.3)

● Install the connection pipes

Connect the connection pipes with the relevant union pipes of the indoor unit (Shown in P25 “Install the connection pipes”).

NOTE:

- Connect the connection pipes with the indoor unit firstly and the outdoor unit secondly.
- Be careful in bending the connection pipes, or you will damage the pipes.
- If the tightening torque is too great in tightening the flare nuts, leakage will happen.

● Electrical wiring

1. Open the surface panel.
2. Remove the wiring cover. (Fig.4)
3. Route the power connection cord from the back of the indoor unit and pull it toward the front through the wiring hole for connection.
4. Connect the blue wire of the power connection cord to the terminal “N(1)”, the brown one to “2”, the black one to “3”, and the yellow- green one (earth wire) to “ \perp ” as shown in Fig.4.

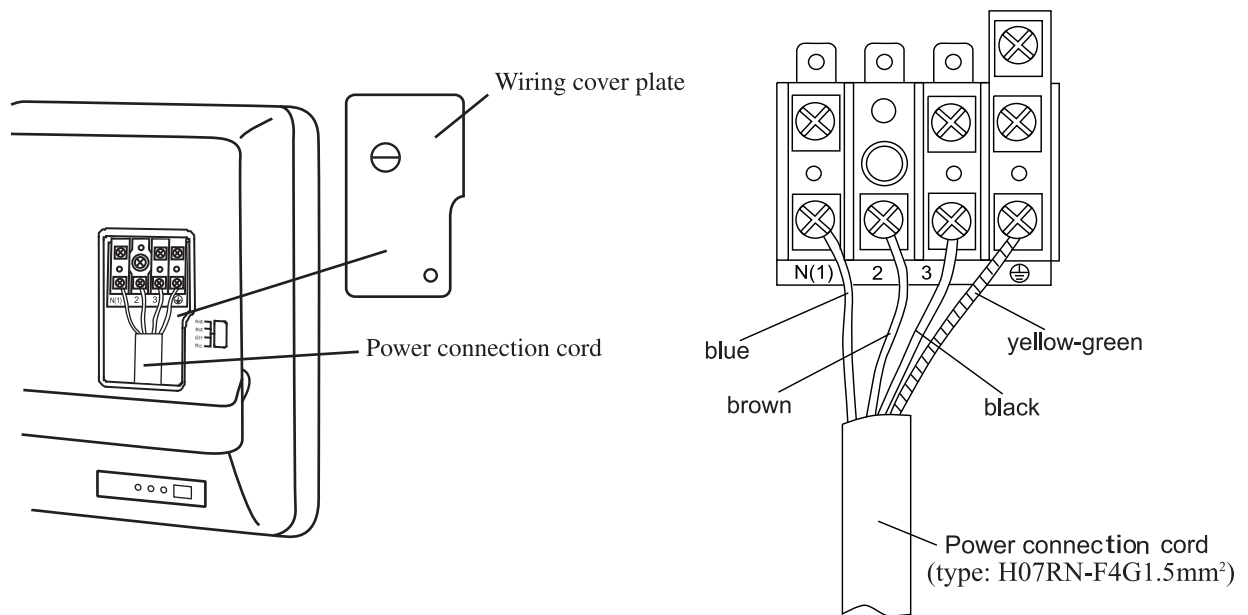

Fig.4

NOTE:

- All the electrical work must be done by qualified personnel according to relative wiring regulation and this manual.
- The power supply is type Y connection. If the supply cord is damaged, it must be replaced by the manufacturer or its service agent or a similarly qualified person in order to avoid a hazard.
- The rated voltage and the exclusive circuit must be used.
- Leakage circuit-breaker and air switch of correct capacity must be installed. The air switch of 32A should be used in these models.

● Install the indoor unit

1. When routing the piping and wiring from the left or right side of the indoor unit, cut off the tailings from the chassis in necessary (shown in Fig.5).

- ① Cut off tailing 1 when only power cord is routed.
- ② Cut off tailings 1 and 2 when connect pipe and power cord are routed.

2. Wrap the piping and wiring and pull them through the cut-off tailings hole (shown in Fig. 6).

3. Hang the 2 mounting slots of the indoor unit on the upper tabs of the rear panel and check if it is firm enough.

4. The height of the installed location should be 2.3m or more from the floor.

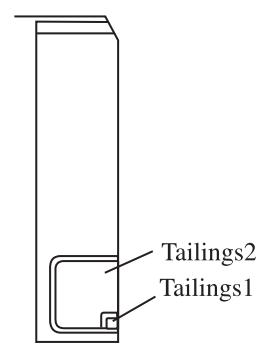

Fig.5

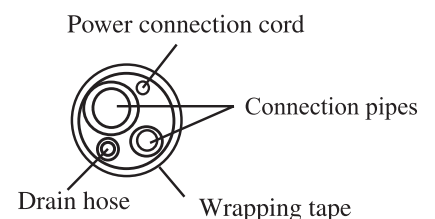

Fig.6

Install the outdoor unit

● Install the connection pipe

- 1.Align the center of the piping flare with the relevant valve.
- 2.Screw in the flare nut by hand and then tighten the nut with spanner and torque wrench refer to the diagram at right.

Note: Exceeding tightening torque will damage the flare surface.

Tightening torque table

Hex nut diameter (mm)	Tightening torque(N.m)
∅ 6	15~20
∅9.5	31~35
∅12	50~55
∅16	60~65

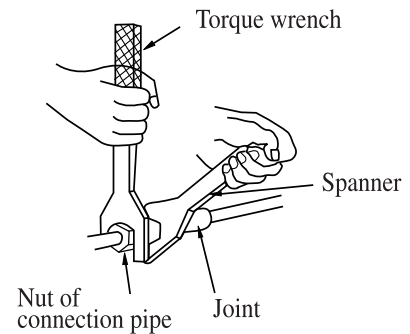

Fig.7

● Electric wiring connection

- 1.Remove the front side plate (Fig.8).
- 2.Break through the hole for wires and put on rubber bush.
- 3.Pull all wires throught the rubber bush.
- 4.Remove the wire clamp and connect the end of the power connection cord with screws to the wiring terminal board according to the "WIRING DIAGRAM" of outdoor unit.
- 5.Make sure that the wiring has been connected firmly.
- 6.Tighten the wire with clamp and clasp.

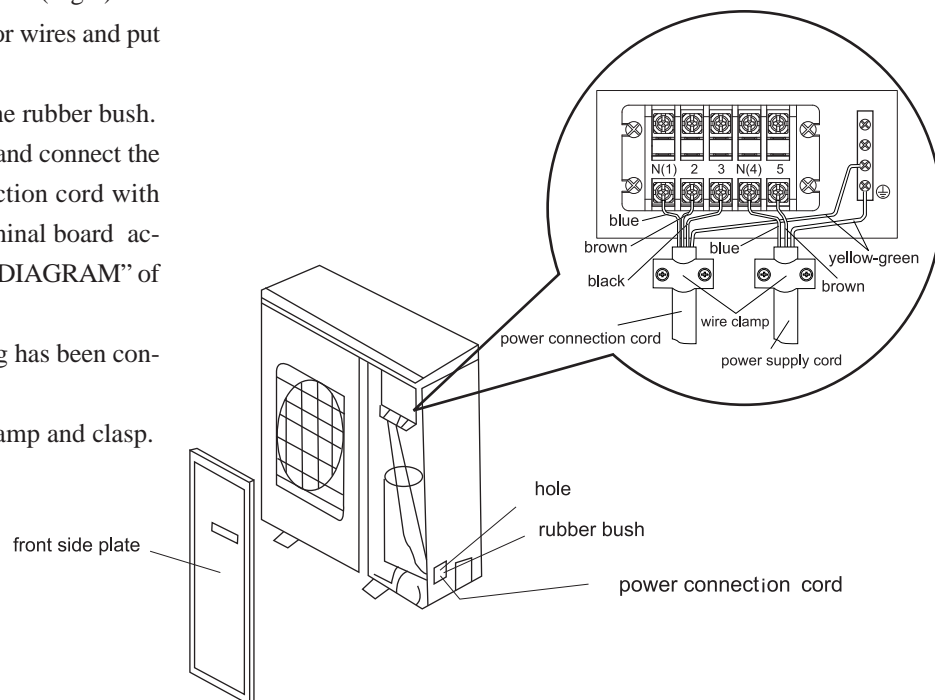

Fig.8

NOTE:

Wrong wiring connection will cause electrical malfunction.

Do not pull the wire when fixing it with wire clamp.

Do not let the wire too loose in the outdoor unit.

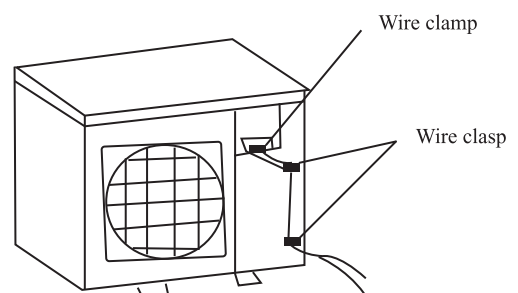

Install the outdoor unit

● Connecting the pipe

- 1.Remove the flare nuts from the cut - off valves of the outdoor unit.
- 2.Align the center of the piping flare with the relevant valve, and screw in the flare nut about 3~4 turns by hand.
- 3.Tighten the flare nut with spanner and torque wrench.
- 4.Remove the valve caps of the gas valve and liquid valve and the service port nut.

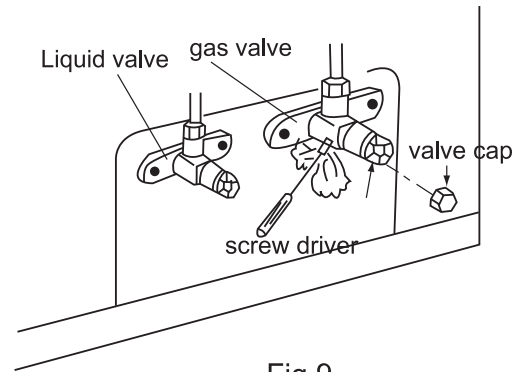

Fig.9

● Air purging and leakage test

For the air conditioners with R22 refrigerant, as the below step:

- 1.Loosen the valve stem of the liquid valve with a hex wrench.
- 2.Push the check valve core of the gas valve to discharge air and moisture remaining in the refrigerant system.
- 3.Stop pushing the valve core as soon as the refrigerant starts to be discharged, and reinstall the service port nut.
- 4.Open the liquid valve and gas valve entirely (shown in Fig.9).
- 5.Tighten the valve caps and test leakage at all joints of the piping (both indoor and outdoor) with liquid soap or leak detector.
- 6.If possible, discharge air and moisture remaining in the refrigerant system with a vacuum pump. (shown in Fig.10)

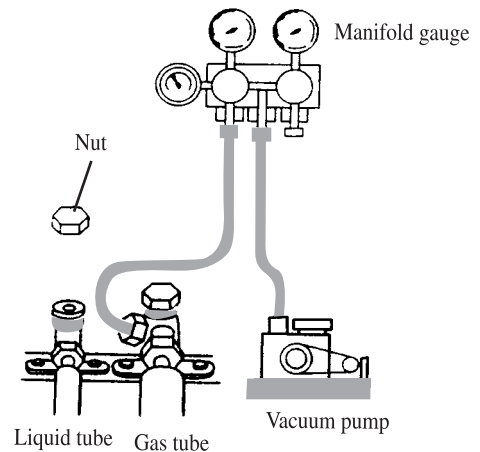

Fig.10

- 1.Remove the nuts of one-way valve.
- 2.Evacuate from the one-way valve with a vacuum pump until the vacuum meter is 5 Torr, and keep up evacuating 1 hour or more.
- 3.Turn off the valve and tighten the nuts.
- 4.Fully open valves.(Fig.9)
- 5.Tighten the nuts, then check whether there is gas leaking out.

*Moisture inside pipeline must be less 200 PPM.

● Outdoor condensation drainage (Heat pump type only)

When the unit is heating or defrosting,the waste water formed in the outdoor unit can be drained out reliably through the drain hose.

Installation:

Install the outdoor drain elbow in the ϕ 25 hole on the base plate as shown in Fig.11, and joint the drain hose to the elbow, so that the waste water formed in the outdoor unit can be drained out to a proper place.

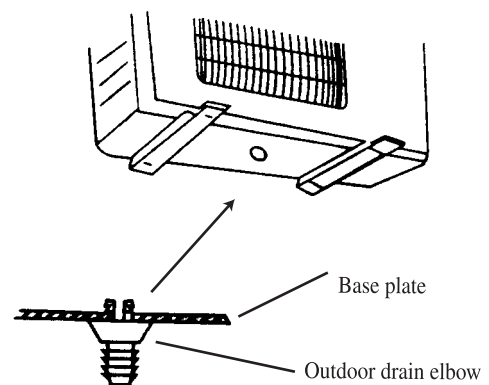

Fig.11

Routine check after installation

● Check after installation

Items to be checked	Possible malfunction	Situation
Has the air conditioner been fixed firmly?	The unit may drop, shake or emit noise.	
Have you done the refrigerant leakage test?	It may cause insufficient refrigerating capacity.	
Is heat insulation sufficient?	It may cause condensation and dripping.	
Does the unit drain well?	It may cause condensation and dripping.	
Is the voltage in accordance with the rated voltage marked on the nameplate?	It may cause electric malfunction or damage the part.	
Is the electrical wiring and piping connection installed correctly and securely?	It may cause electric malfunction or damage the part.	
Has the unit been connected to a secure earth connection?	It may cause electrical leakage.	
Is the power cord specified?	It may cause electric malfunction or damage the part.	
Has the inlet and outlet been covered?	It may cause insufficient refrigerating capacity.	
Has the length of connection pipes and the refrigerant capacity been recorded?	The refrigerant capacity is not accurate.	

請填妥以下空格並與發票一併保存，以便維修時核對資料。用戶提供本公司之所有資料必須正確無誤，否則免費保用將會無效。
Please fill out the form below. This information and the purchase invoice will be required for any repairs. Warranty will be invalid if information provided is found to be inaccurate.

型號 Model No. : ST-24

機身號碼 Serial No. : _____ 發票號碼 Invoice No. : _____

購買商號 Purchased From : _____ 購買日期 Purchase Date : _____

保用條例

此保用提供德國寶產品之機件在正常使用下壹年(自購買日起計算)保用，壓縮器保用五年(此保用只包括每年續保客戶)，但不包括安裝，維修、雪種、保養及更換零件之人工或其他費用。

* 貴戶須在購機十天內，以下列其中一種方式向本公司登記資料，保用手續方正式生效：

- 1) 填妥本公司網頁內之保用登記表格
www.germanpool.com/warranty
- 2) 填妥保用登記卡，並連同購機發票之副本一併郵寄到維修及客戶服務部
(本公司將不發還發票副本或登記卡)

* 此保用不包括：非家庭性質用途；燈泡及塑膠配件；因意外而造成的損壞(包括運輸及其它)；任何附件及輔助裝置；以及一切因人為、電源接合不當、不依說明書而錯誤或疏忽使用本機、經非本公司認可之安裝及不適當維修等等所引致之損壞。

** 保用只在香港、九龍、新界區有效，東涌、愉景灣及離島，需額外收取交通費用。

維修及客戶服務部

德國寶(香港)有限公司
香港九龍土瓜灣馬頭角道116號
新寶工商中心高層地下2-3號室
電話：+852 2333 6249
傳真：+852 2355 7100
電郵：repairs@germanpool.com

Warranty Terms & Conditions

Our Repairs & Customer Service Centre will provide rectification of any defect of manufacturing materials free of charge given that such defect is reported within 12 months from date of sale.

* This warranty is not valid until Customer's registration information is returned to and received by our Service Centre within 10 days of purchase via one of the following methods:

- 1) Visit our website and register online:
www.germanpool.com/warranty
- 2) Complete all fields on the attached Warranty Card and mail it back to our Repairs & Customer Service Centre along with a photocopy of the purchase invoice (Warranty Card and invoice copy will not be returned to Customer)

* Product must be used solely for domestic purposes. Customer should always follow the operating instructions. This warranty does not apply to: replacement of accessories and parts; damages caused by incorrect voltage, improper operations, unauthorized installation or repairs as well as accidents.

** Service area includes Hong Kong Island, Kowloon and New Territories. Repairs in Tung Chung, Discovery Bay or other areas are subject to extra service charge.

Repairs & Customer Service Centre

German Pool (Hong Kong) Limited
Room 2 & 3, Upper Ground Floor
Newport Centre, 116 Ma Tau Kok Road
Tokwawan, Kowloon, Hong Kong
Tel : +852 2333 6249
Fax : +852 2355 7100
Email : repairs@germanpool.com

GERMAN
POOL  **德國寶**

德國寶(香港)有限公司 German Pool (Hong Kong) Limited

香港九龍土瓜灣馬頭角道116號新寶工商中心高層地下2-3號室
Room 2 & 3, Upper Ground Floor, Newport Centre
116 Ma Tau Kok Road, Tokwawan, Kowloon, Hong Kong

電話 (Tel) :
+852 2333 6245
+852 2773 2888

傳真 (Fax) :
+852 2765 8215
+852 2365 6009

電郵 (E-mail) :
info@germanpool.com

www.germanpool.com